

SP4022 Series 1.3pF, 15A Discrete TVS Diode



Description

The SP4022 series integrates low capacitance steering diodes with one or two zener diodes for unidirectional or bidirectional protection, respectively, to protect against ESD and lightning induced surge events. These devices can safely absorb up to 15A per IEC 61000-4-5 2nd Edition ($t_p=8/20\mu s$) without performance degradation and a minimum $\pm 30kV$ ESD per IEC61000-4-2 International Standard. The low loading capacitance and high surge capability make it ideal for protecting telecommunication ports such as xDSL and other high voltage, high speed legacy interfaces.

Pinout



Features

- ESD, IEC 61000-4-2, $\pm 30kV$ contact, $\pm 30kV$ air
- EFT, IEC 61000-4-4, 40A (5/50ns)
- Lightning, IEC 61000-4-5 2nd Edition, 15A ($t_p=8/20\mu s$)
- Low capacitance of 1.3pF (@ $V_R=0V$)
- Low leakage current
- Unidirectional and Bidirectional configuration
- Small SOD323 package fits 0805 footprints
- AEC-Q101 qualified
- RoHS Compliant and Lead Free

Functional Block Diagram

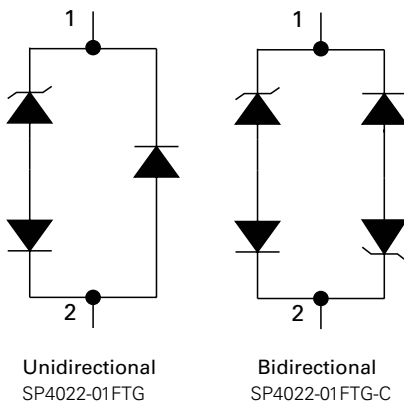

Applications

- xDSL Interfaces
- RS-232
- RS-485
- Power Ports
- Security Equipment
- Instrumentation
- Medical Equipment
- Computers and Peripherals

Additional Information



[Datasheet](#)



[Resources](#)



[Samples](#)

Life Support Note:

Not Intended for Use in Life Support or Life Saving Applications

The products shown herein are not designed for use in life sustaining or life saving applications unless otherwise expressly indicated.

Absolute Maximum Ratings

Symbol	Parameter	Value	Units
I_{PP}	Peak Current ($t_p=8/20\mu s$)	15	A
P_{PK}	Peak Pulse Power ($t_p=8/20\mu s$)	500	W
T_{OP}	Operating Temperature	-40 to 150	°C
T_{STOR}	Storage Temperature	-55 to 150	°C

Notes:

CAUTION: Stresses above those listed in "Absolute Maximum Ratings" may cause permanent damage to the device. This is a stress only rating and operation of the device at these or any other conditions above those indicated in the operational sections of this specification is not implied.

Thermal Information

Parameter	Rating	Units
Storage Temperature Range	-55 to 150	°C
Maximum Junction Temperature	150	°C
Maximum Lead Temperature (Soldering 20-40s)	260	°C

Electrical Characteristics ($T_{OP}=25^\circ C$)

Parameter	Symbol	Test Conditions	Min	Typ	Max	Units
Reverse Standoff Voltage	V_{RWM}	$I_R \leq 1\mu A$ with Pin 1 to Pin 2			12	V
Breakdown Voltage	V_{BD}	$I_T = 1mA$ with Pin 1 to Pin 2	13.3			V
Leakage Current	I_{LEAK}	$V_R = 12V$ with Pin 1 to Pin 2			0.1	μA
Clamp Voltage ¹	V_C	$I_{PP} = 1A, t_p = 8/20\mu s, Fwd$		19		V
		$I_{PP} = 2A, t_p = 8/20\mu s, Fwd$		20		V
		$I_{PP} = 10A, t_p = 8/20\mu s, Fwd$		28		V
		$I_{PP} = 15A, t_p = 8/20\mu s, Fwd$		33	35	V
Dynamic Resistance ²	R_{DYN}	TLP $t_p = 100ns$, Pin 1 to Pin 2		0.5		Ω
ESD Withstand Voltage ¹	V_{ESD}	IEC61000-4-2 (Contact Discharge)	± 30			kV
		IEC61000-4-2 (Air Discharge)	± 30			kV
Diode Capacitance ¹	C_D	Reverse Bias=0V, f=1MHz, Pin 1 to Pin 2		1.3	2	pF

Note:

¹Parameter is guaranteed by design and/or device characterization.

² Transmission Line Pulse (TLP) test setting : Std.TDR(50 Ω), $t_p=100ns$, $t_r=0.2ns$ ITLP and VTLP averaging window: star $t_1=70ns$ to end $t_2=80ns$

8/20 μs Pulse Waveform

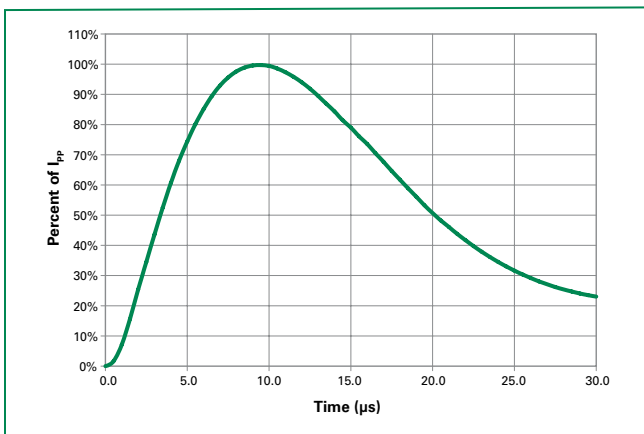

Capacitance vs. Reverse Bias (Pin 1 to Pin 2)

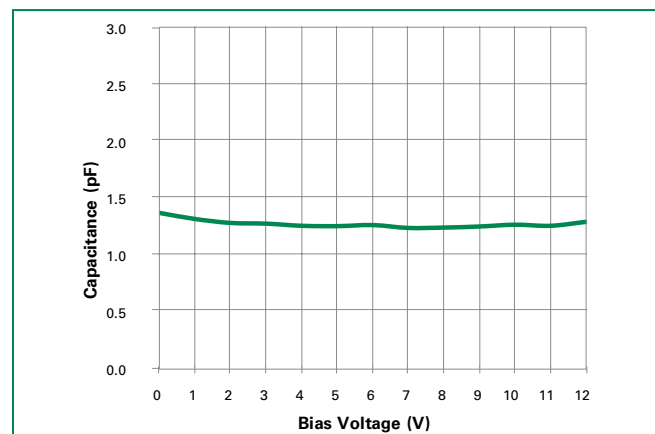

Clamping Voltage vs. Peak Pulse Current (Pin 1 to Pin 2)

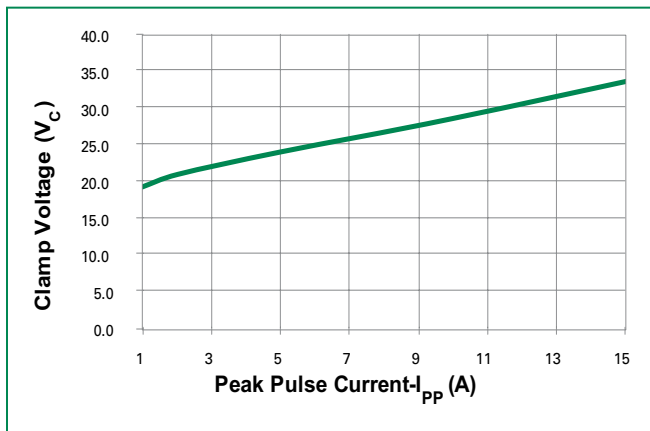

Transmission Line Pulsing (TLP) Plot (Pin 1 to Pin2)

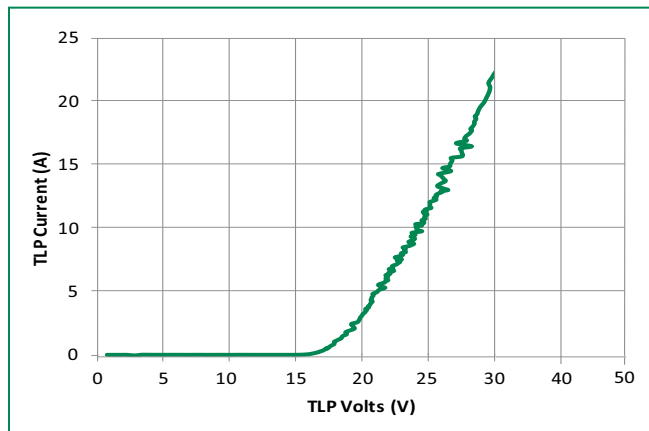

Soldering Parameters

Reflow Condition		Pb – Free assembly
Pre Heat	- Temperature Min ($T_{s(min)}$)	150°C
	- Temperature Max ($T_{s(max)}$)	200°C
	- Time (min to max) (t_s)	60 – 180 secs
Average ramp up rate (Liquidus) Temp (T_L) to peak		3°C/second max
$T_{s(max)}$ to T_L - Ramp-up Rate		3°C/second max
Reflow	- Temperature (T_L) (Liquidus)	217°C
	- Temperature (t_L)	60 – 150 seconds
Peak Temperature (T_p)		260 ^{+0/-5} °C
Time within 5°C of actual peak Temperature (t_p)		20 – 40 seconds
Ramp-down Rate		6°C/second max
Time 25°C to peak Temperature (T_p)		8 minutes Max.
Do not exceed		260°C

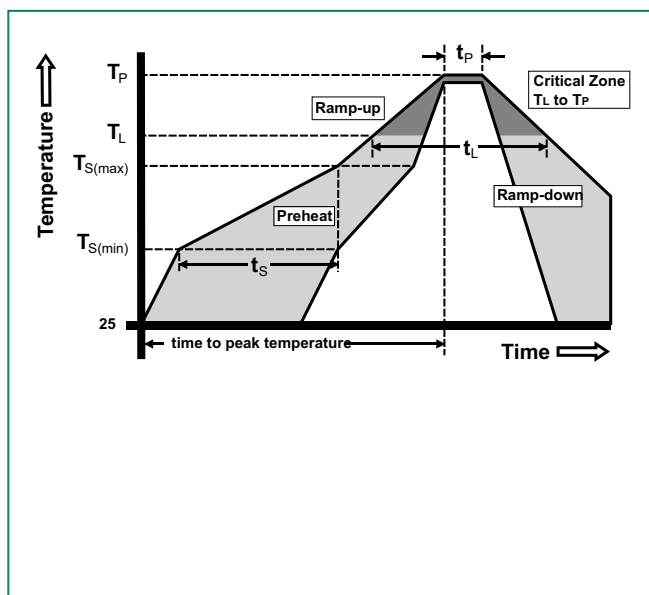

Product Characteristics

Lead Plating	Matte Tin
Lead Material	Copper Alloy
Lead Coplanarity	0.0004 inches (0.102mm)
Substrate material	Silicon
Body Material	V-0 per UL 94 Molded Epoxy

- Notes :
1. All dimensions are in millimeters.
 2. Dimensions include solder plating.
 3. Dimensions are exclusive of mold flash & metal burr.
 4. Blo is facing up for mold and facing down for trim/form, i.e. reverse trim/form.
 5. Package surface matte finish VDI 11-13.

Part Marking System

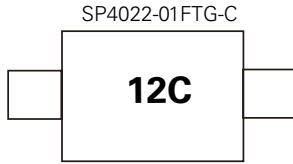
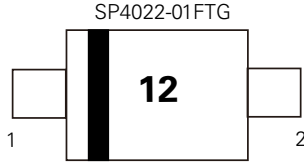

Part Numbering System

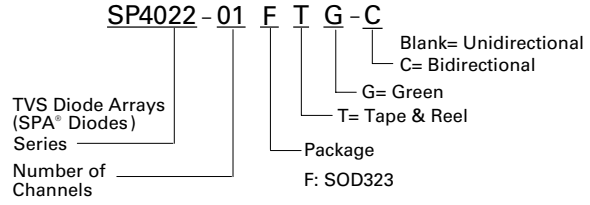

Ordering Information

Part Number	Package	Marking	Min. Order Qty.
SP4022-01FTG	SOD323	12	3000
SP4022-01FTG-C	SOD323	12C	3000

Package Dimensions -SOD323

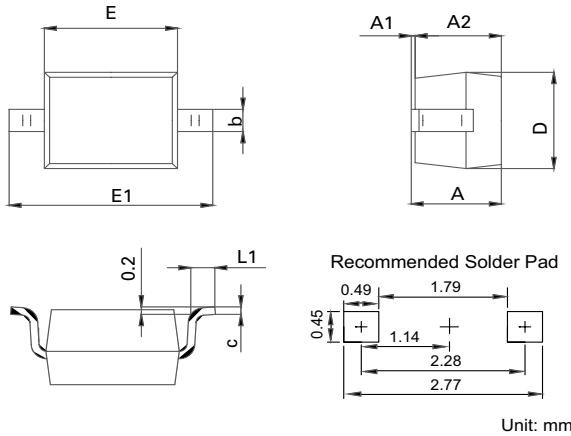

Symbol	SOD323			
	Millimeters		Inches	
	Min	Max	Min	Max
A	0.80	1.14	0.031	0.045
A1	0.00	0.10	0.000	0.004
A2	0.80	1.04	0.031	0.014
b	0.25	0.35	0.010	0.014
c	0.08	0.15	0.003	0.006
D	1.15	1.45	0.045	0.057
E	1.60	1.90	0.063	0.075
E1	2.44	2.75	0.096	0.108
L1	0.22	0.45	0.009	0.018

Embossed Carrier Tape & Reel Specification – SOD323

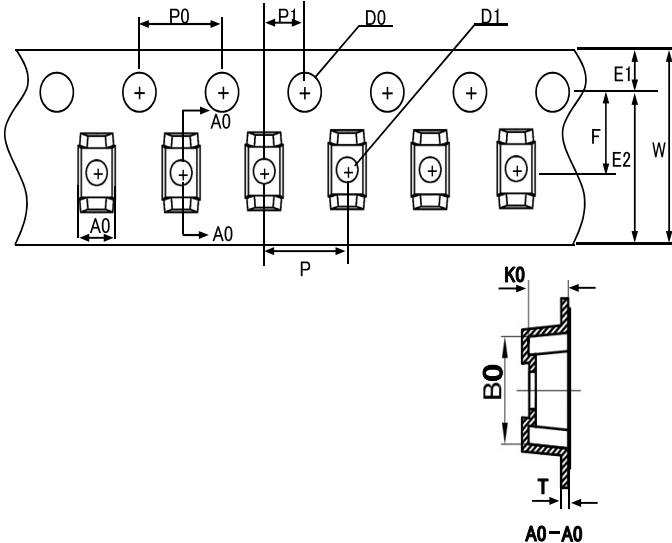

Symbol	Dimensions (mm)
A0	1.46 +/- 0.1
B0	2.90 +/- 0.1
W	8.0 +0.3 / - 0.10
D0	ø1.50 +0.1
D1	0.45 ~ 1.15
E1	1.75 +/- 0.10
E2	--
F	3.50 +/- 0.10
P0	4.0 +/- 0.10
P	4.0 +/- 0.10
P1	2.0 +/- 0.05
K0	1.25 +/- 0.1
T	0.254 +/- 0.02