



**MICROCHIP**

---

**MCP47X6  
PICtail™ Plus  
Daughter Board  
User's Guide**

---

**Note the following details of the code protection feature on Microchip devices:**

- Microchip products meet the specification contained in their particular Microchip Data Sheet.
- Microchip believes that its family of products is one of the most secure families of its kind on the market today, when used in the intended manner and under normal conditions.
- There are dishonest and possibly illegal methods used to breach the code protection feature. All of these methods, to our knowledge, require using the Microchip products in a manner outside the operating specifications contained in Microchip's Data Sheets. Most likely, the person doing so is engaged in theft of intellectual property.
- Microchip is willing to work with the customer who is concerned about the integrity of their code.
- Neither Microchip nor any other semiconductor manufacturer can guarantee the security of their code. Code protection does not mean that we are guaranteeing the product as "unbreakable."

Code protection is constantly evolving. We at Microchip are committed to continuously improving the code protection features of our products. Attempts to break Microchip's code protection feature may be a violation of the Digital Millennium Copyright Act. If such acts allow unauthorized access to your software or other copyrighted work, you may have a right to sue for relief under that Act.

---

Information contained in this publication regarding device applications and the like is provided only for your convenience and may be superseded by updates. It is your responsibility to ensure that your application meets with your specifications. MICROCHIP MAKES NO REPRESENTATIONS OR WARRANTIES OF ANY KIND WHETHER EXPRESS OR IMPLIED, WRITTEN OR ORAL, STATUTORY OR OTHERWISE, RELATED TO THE INFORMATION, INCLUDING BUT NOT LIMITED TO ITS CONDITION, QUALITY, PERFORMANCE, MERCHANTABILITY OR FITNESS FOR PURPOSE. Microchip disclaims all liability arising from this information and its use. Use of Microchip devices in life support and/or safety applications is entirely at the buyer's risk, and the buyer agrees to defend, indemnify and hold harmless Microchip from any and all damages, claims, suits, or expenses resulting from such use. No licenses are conveyed, implicitly or otherwise, under any Microchip intellectual property rights.

**Trademarks**

The Microchip name and logo, the Microchip logo, dsPIC, KEELOQ, KEELOQ logo, MPLAB, PIC, PICmicro, PICSTART, PIC<sup>32</sup> logo, rfPIC and UNI/O are registered trademarks of Microchip Technology Incorporated in the U.S.A. and other countries.


FilterLab, Hampshire, HI-TECH C, Linear Active Thermistor, MXDEV, MXLAB, SEEVAL and The Embedded Control Solutions Company are registered trademarks of Microchip Technology Incorporated in the U.S.A.

Analog-for-the-Digital Age, Application Maestro, chipKIT, chipKIT logo, CodeGuard, dsPICDEM, dsPICDEM.net, dsPICworks, dsSPEAK, ECAN, ECONOMONITOR, FanSense, HI-TIDE, In-Circuit Serial Programming, ICSP, Mindi, MiWi, MPASM, MPLAB Certified logo, MPLIB, MPLINK, mTouch, Omniscient Code Generation, PICC, PICC-18, PICDEM, PICDEM.net, PICkit, PICtail, REAL ICE, rfLAB, Select Mode, Total Endurance, TSHARC, UniWinDriver, WiperLock and ZENA are trademarks of Microchip Technology Incorporated in the U.S.A. and other countries.

SQTP is a service mark of Microchip Technology Incorporated in the U.S.A.

All other trademarks mentioned herein are property of their respective companies.

© 2011, Microchip Technology Incorporated, Printed in the U.S.A., All Rights Reserved.

 Printed on recycled paper.

ISBN: 978-1-61341-709-6

**QUALITY MANAGEMENT SYSTEM**  
**CERTIFIED BY DNV**  
**== ISO/TS 16949:2009 ==**

*Microchip received ISO/TS-16949:2009 certification for its worldwide headquarters, design and wafer fabrication facilities in Chandler and Tempe, Arizona; Gresham, Oregon and design centers in California and India. The Company's quality system processes and procedures are for its PIC<sup>®</sup> MCUs and dsPIC<sup>®</sup> DSCs, KEELOQ<sup>®</sup> code hopping devices, Serial EEPROMs, microperipherals, nonvolatile memory and analog products. In addition, Microchip's quality system for the design and manufacture of development systems is ISO 9001:2000 certified.*



# MCP47X6 PICtail™ PLUS DAUGHTER BOARD USER'S GUIDE

---

---

## Table of Contents

---

---

<b>Preface</b> .....	<b>5</b>
Introduction.....	5
Document Layout .....	5
Conventions Used in this Guide .....	6
Recommended Reading.....	7
The Microchip Web Site .....	7
Customer Support .....	7
Document Revision History .....	8
<b>Chapter 1. Quick Start Instructions</b>	
1.1 Introduction .....	9
1.2 Description of the MCP47X6 PICtail™ Plus Daughter Board .....	9
1.3 I2C Address Byte for Each Device .....	11
1.4 Getting Started With the Explorer 16 Development Board .....	12
1.5 Connecting to the Explorer 16 Starter Kit .....	13
1.6 Getting Started with PICKit™ Serial Analyzer .....	20
1.7 Examples for Other Devices (MCP4706, MCP4716) .....	30
1.8 Programming Example using the PICKit™ Serial Analyzer .....	31
<b>Appendix A. Schematic and Layouts</b>	
A.1 Introduction .....	33
A.2 Board – Schematic .....	34
A.3 Board – Top Silk and Pads .....	35
A.4 Board – Top Copper, Top Pads and Top Silk .....	36
A.5 Board – Bottom Silk and Pads .....	37
A.6 Board – Bottom Copper, Bottom Pads and Silk .....	38
<b>Appendix B. Bill Of Materials (BOM)</b>	
<b>Worldwide Sales and Service</b> .....	<b>40</b>

# **MCP47X6 PICtail™ Plus Daughter Board User's Guide**

---

---



# MCP47X6 PICtail™ PLUS DAUGHTER BOARD USER'S GUIDE

## Preface

### NOTICE TO CUSTOMERS

All documentation becomes dated, and this manual is no exception. Microchip tools and documentation are constantly evolving to meet customer needs, so some actual dialogs and/or tool descriptions may differ from those in this document. Please refer to our web site ([www.microchip.com](http://www.microchip.com)) to obtain the latest documentation available.

Documents are identified with a “DS” number. This number is located on the bottom of each page, in front of the page number. The numbering convention for the DS number is “DSXXXXA”, where “XXXX” is the document number and “A” is the revision level of the document.

For the most up-to-date information on development tools, see the MPLAB® IDE online help. Select the Help menu, and then Topics to open a list of available online help files.

## INTRODUCTION

This chapter contains general information that will be useful to know before using the MCP47X6 PICtail™ Plus Daughter Board. Items discussed in this chapter include:

- Document Layout
- Conventions Used in this Guide
- Recommended Reading
- The Microchip Web Site
- Customer Support
- Document Revision History

## DOCUMENT LAYOUT

This document describes how to use the MCP47X6 PICtail™ Plus Daughter Board as a development tool to emulate and debug firmware on a target board. The manual layout is as follows:

- **Chapter 1. “Quick Start Instructions”** – this chapter provides an overview of the MCP47X6 PICtail™ Plus Daughter Board and instructions on how to program the DAC register and EEPROM of the MCP4706/MCP4716/MCP4726 devices.
- **Appendix A. “Schematic and Layouts”** – shows the schematic and layout diagrams for the MCP47X6 PICtail™ Plus Daughter Board.
- **Appendix B. “Bill Of Materials (BOM)”** – lists the parts used to build the MCP47X6 PICtail™ Plus Daughter Board.

# MCP47X6 PICtail™ Plus Daughter Board User's Guide

## CONVENTIONS USED IN THIS GUIDE

This manual uses the following documentation conventions:

### DOCUMENTATION CONVENTIONS

Description	Represents	Examples
<b>Arial font:</b>		
Italic characters	Referenced books	<i>MPLAB® IDE User's Guide</i>
	Emphasized text	...is the <i>only</i> compiler...
Initial caps	A window	the Output window
	A dialog	the Settings dialog
	A menu selection	select Enable Programmer
Quotes	A field name in a window or dialog	"Save project before build"
Underlined, italic text with right angle bracket	A menu path	<u><i>File&gt;Save</i></u>
Bold characters	A dialog button	Click <b>OK</b>
	A tab	Click the <b>Power</b> tab
N'Rnnnn	A number in verilog format, where N is the total number of digits, R is the radix and n is a digit.	4'b0010, 2'hF1
Text in angle brackets < >	A key on the keyboard	Press <Enter>, <F1>
<b>Courier New font:</b>		
Plain Courier New	Sample source code	#define START
	Filenames	autoexec.bat
	File paths	c:\mcc18\h
	Keywords	_asm, _endasm, static
	Command-line options	-Opa+, -Opa-
	Bit values	0, 1
	Constants	0xFF, 'A'
Italic Courier New	A variable argument	<i>file.o</i> , where <i>file</i> can be any valid filename
Square brackets [ ]	Optional arguments	mcc18 [options] <i>file</i> [options]
Curly brackets and pipe character: {   }	Choice of mutually exclusive arguments; an OR selection	errorlevel {0 1}
Ellipses...	Replaces repeated text	var_name [, var_name...]
	Represents code supplied by user	void main (void) { ... }

## RECOMMENDED READING

This user's guide describes how to use MCP47X6 PICtail™ Plus Daughter Board. The following Microchip documents are available and recommended as supplemental reference resources.

### **PICkit™ Serial Analyzer User's Guide (DS51647)**

Consult this document for instructions on how to use the PICkit™ Serial Analyzer hardware and software.

### **MCP4706/MCP4716/MCP4726 Data Sheet, "8-/10-/12-Bit Voltage Output Digital-to-Analog Converter with EEPROM Memory" (DS22272)**

This data sheet provides detailed information regarding the MCP47x6 product family.

### **PIC24FJ128GA010 Family Data Sheet (DS39747)**

### **Explorer 16 Development Board User's Guide (DS51589)**

### **AN1079, "Using the C30 Compiler and the I2C Peripheral to Interface Serial EEPROMs with dsPIC33F" (DS01079)**

## THE MICROCHIP WEB SITE

Microchip provides online support via our web site at [www.microchip.com](http://www.microchip.com). This web site is used as a means to make files and information easily available to customers. Accessible by using your favorite Internet browser, the web site contains the following information:

- **Product Support** – Data sheets and errata, application notes and sample programs, design resources, user's guides and hardware support documents, latest software releases and archived software
- **General Technical Support** – Frequently Asked Questions (FAQs), technical support requests, online discussion groups, Microchip consultant program member listing
- **Business of Microchip** – Product selector and ordering guides, latest Microchip press releases, listing of seminars and events, listings of Microchip sales offices, distributors and factory representatives

## CUSTOMER SUPPORT

Users of Microchip products can receive assistance through several channels:

- Distributor or Representative
- Local Sales Office
- Field Application Engineer (FAE)
- Technical Support

Customers should contact their distributor, representative or field application engineer (FAE) for support. Local sales offices are also available to help customers. A listing of sales offices and locations is included in the back of this document.

Technical support is available through the web site at: <http://support.microchip.com>.

# MCP47X6 PICtail™ Plus Daughter Board User's Guide

---

## DOCUMENT REVISION HISTORY

### Revision B (October 2011)

- Replaced the front and back views of the board with updated photos for [Figure 1-1: “Front and Back Views of the MCP47X6 PICtail™ Plus Daughter Board.”](#)
- Added buzzer information to [Appendix B. “Bill Of Materials \(BOM\)”](#).

### Revision A (May 2011)

- Initial Release of this Document.





# MCP47X6 PICtail™ PLUS DAUGHTER BOARD USER'S GUIDE

## Chapter 1. Quick Start Instructions

### 1.1 INTRODUCTION

The following sections provide an overview of the MCP47X6 PICtail™ Plus Daughter Board and demonstrate how to: (a) use these devices in a 16-bit MCU environment and (b) evaluate these device's features using the PICkit™ Serial Analyzer (P/N: DV164122). The MCP47X6 PICtail™ Plus Daughter Board is designed to work with both the Explorer 16 Development Board (P/N: DV164033) and the PICkit™ Serial Analyzer (P/N: DV164122).

The following topics are covered:

- Description of the MCP47X6 PICtail™ Plus Daughter Board.
- How to use the MCP47X6 PICtail™ Plus Daughter Board with the Explorer 16 Starter Kit.
- How to use MCP47X6 PICtail™ Plus Daughter Board with the PICkit™ Serial Analyzer.

**Note 1:** If you use the PIC Explorer 16, you need Sections 1.4 — 1.5 only.  
**2:** If you use the PICkit™ Serial Analyzer, you need Sections 1.6 — 1.8 only.

### 1.2 DESCRIPTION OF THE MCP47X6 PICtail™ PLUS DAUGHTER BOARD

The MCP47X6 PICtail™ Plus Daughter Board (P/N ADM00317) contains the MCP4706 (8-bit DAC), MCP4716 (10-bit DAC), and MCP4726 (12-bit DAC) devices. These DAC devices are communicating with the external Master device (MCU) using I<sup>2</sup>C serial interface communication. The MCP47X6 PICtail™ Plus Daughter Board does not include the Master device (MCU), but it has two interface connectors that can be used for the external device, which has the Master device (MCU) to communicate with this board. The two interfaces are:

**(a)** Connector (J3) for Explorer 16 Starter Kit (P/N: DV164033) for 16-bit MCU environment. The firmware for the 16-bit MCU is provided with this board.

**(b)** 6-pin connector (J1) for PICkit™ Serial Analyzer (P/N: DV164122) for reading and writing the DAC registers using the PICkit™ Serial Analyzer PC software.

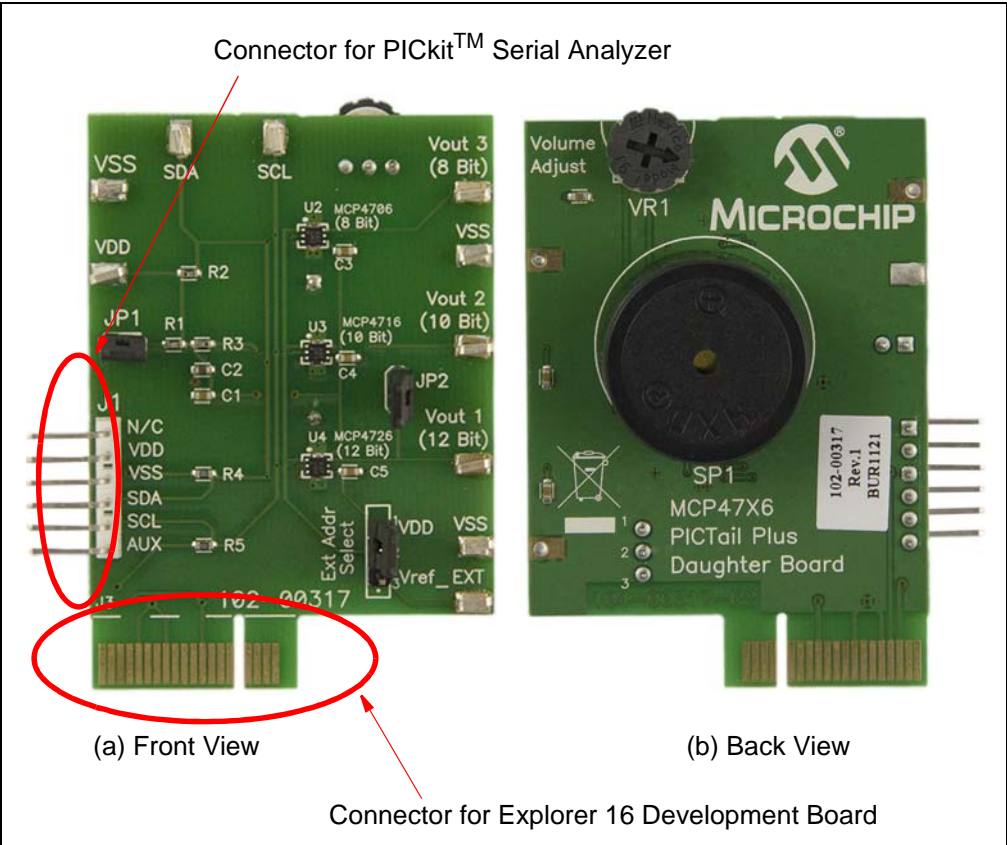
The user can connect the MCP47X6 PICtail™ Plus Daughter Board to one of the above tools and perform their own experiments.

These two external devices are used to control the DAC devices on the daughter board. The user can choose one of these tools to use along with the daughter board.

The MCP47X6 PICtail™ Plus Daughter Board has test points for SCL and SDA, and V<sub>OUT</sub> pads for each device. By connecting an oscilloscope to these test points (to SCL, SDA, V<sub>OUT</sub>) or a digital multimeter to the V<sub>OUT</sub> pads, the user can examine the data communications through the I<sup>2</sup>C™ bus line and observe the resulting DAC output (V<sub>OUT</sub>). Refer to [Appendix A. “Schematic and Layouts”](#).

**Note:** The user can also control the DAC devices on the MCP47X6 PICtail™ Plus Daughter Board by providing I<sup>2</sup>C commands through the interface communication terminals on the daughter board, without using the Explorer 16 Development Board or the PICkit™ Serial Analyzer.

# MCP47X6 PICtail™ Plus Daughter Board User's Guide



**FIGURE 1-1:** Front and Back Views of the MCP47X6 PICtail™ Plus Daughter Board.

**TABLE 1-1: TERMINAL FUNCTION TABLE**

Connector/Pin/Terminal Name	Functions
J1 Connector	Connector for PICkit™ Serial Analyzer. <b>Note:</b> Do not use this pin when this board is used with the Explorer 16 Development Board.
J3 Connector	Connector for Explorer 16 Development Board. <b>Note:</b> Do not use this pin when this board is used with the PICkit™ Serial Analyzer.
External Reference Selection Jumper Pins	(a) Connect pin 2 to “V <sub>REF_EXT</sub> ” if external reference is applied at the V <sub>REF_EXT</sub> pin. (b) Connect pin 2 to “V <sub>DD</sub> ” if V <sub>DD</sub> is used as reference externally. <b>Note:</b> This pin does not affect if V <sub>DD</sub> is selected as reference internally by the configuration bit setting.
JP1	V <sub>DD</sub> connection through (a) J1 Connector for PICkit™ Serial Analyzer, or (b) J3 Connector for Explorer 16 Development Board.
JP2	Connecting V <sub>OUT 1</sub> (MCP4726 output) to Buzzer. <b>Note:</b> Do not connect this jumper if you don't need audible sounds.
V <sub>DD</sub>	(a) V <sub>DD</sub> monitoring terminal when JP1 is connected (V <sub>DD</sub> is provided by the external tools). (b) V <sub>DD</sub> connection terminal when JP2 is disconnected. You can connect your own V <sub>DD</sub> to this pin.
V <sub>SS</sub>	Ground Reference
V <sub>OUT 1</sub>	DAC output terminal from MCP4726 (12-bit DAC).
V <sub>OUT 2</sub>	DAC output terminal from MCP4716 (10-bit DAC).
V <sub>OUT 3</sub>	DAC output terminal from MCP4706 (8-bit DAC).
V <sub>REF_EXT</sub>	External Reference connection terminal
SDA	Connected to I <sup>2</sup> C™ SDA line
SCL	Connected to I <sup>2</sup> C™ SCL line
VR1	Volume control for Buzzer 1. <b>Note:</b> Disconnect JP2 if you don't need audible sounds.

## 1.3 I<sup>2</sup>C ADDRESS BYTE FOR EACH DEVICE

Each DAC device on the board has its own I<sup>2</sup>C address bits which are preprogrammed at the factory. Table 1-2 shows the I<sup>2</sup>C address byte of each device.

**TABLE 1-2: I<sup>2</sup>C ADDRESS BYTE OF EACH DAC DEVICE**

Device	Address Byte (1st Byte): Device Code + Address Bits (A2, A1, A0) + R/W	I <sup>2</sup> C Address Byte for Write Command (1st Byte)	I <sup>2</sup> C Address Byte for Read Command (1st Byte)
MCP4726 (12-bit DAC)	1100-000R/W	1100-0000	1100-0001
MCP4716 (10-bit DAC)	1100-001R/W	1100-0010	1100-0011
MCP4726 (8-bit DAC)	1100-010R/W	1100-0100	1100-0101

where R/W = 0 for write command and 1 for read command.

# MCP47X6 PICtail™ Plus Daughter Board User's Guide

---

## 1.4 GETTING STARTED WITH THE EXPLORER 16 DEVELOPMENT BOARD

This section describes how to use the MCP47X6 PICtail™ Plus Daughter Board with the Explorer 16 Development Board.

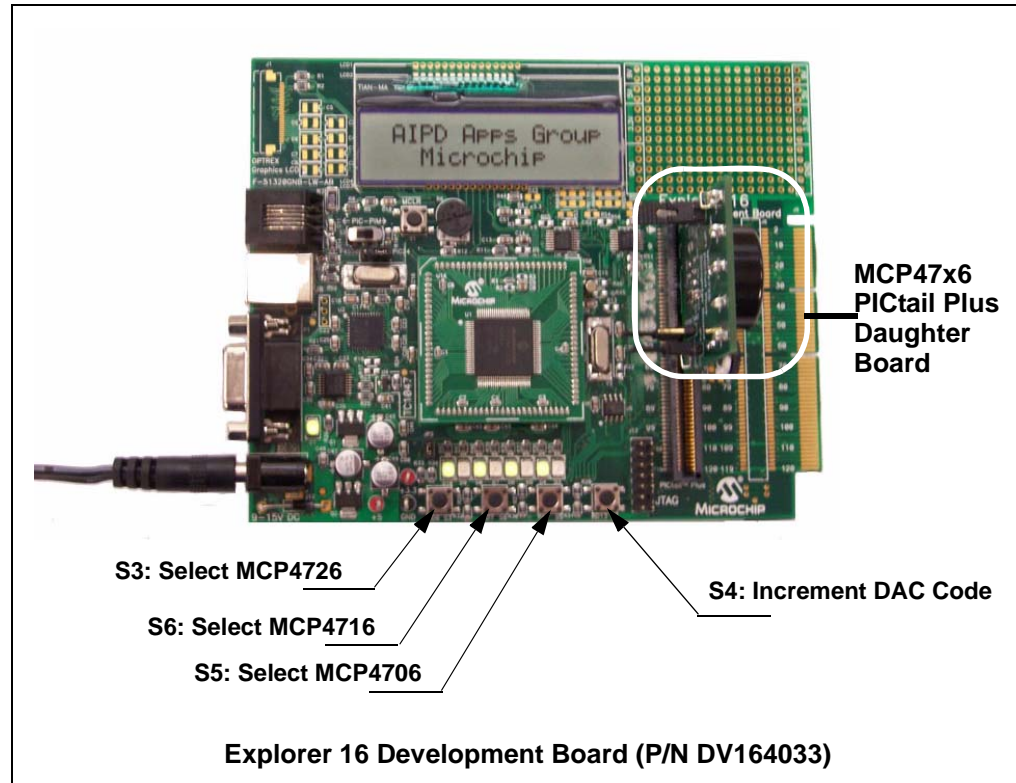
After receiving the MCP47X6 PICtail™ Plus Daughter Board, program the 16-bit PIC24FJ128 MCU on the Explorer 16 Starter Kit using the firmware provided. The user can download the latest firmware from the Microchip website: [www.microchip.com](http://www.microchip.com).

- **Step 1:** Insert the MCP47X6 PICtail™ Plus Daughter Board to the Explorer 16 Development Board. Figure 1-2 shows the configuration when the board is connected to the Explorer 16 Development Board.
- **Step 2:** Program the Explorer 16 Development Board using the firmware provided with this board. Figure 1-3 shows the connection of the MPLAB ICD2 with the Explorer 16 Development Board for programming.
- **Step 3:** Once the programming is done, disconnect the MPLAB ICD2 from the Explorer 16 Development Board.
- **Step 4:** Now you can evaluate the performance of the DAC devices. The LCD on the Explorer 16 Development Board will display instructions on how to select the DAC device using the push button switches on the Development Board: (a) S3 for MCP4726, (b) S6 for MCP4716, and (c) S5 for MCP4706. S4 is used to increment the DAC code. If you hold down the S4 switch, the DAC code will increase continuously until it reaches the maximum value, and then it starts from code 0 again. You can observe this event by simply connecting a voltmeter at the  $V_{OUT}$  pin while holding down the S4 switch.

All procedures are very intuitive and interactive using the Push button switches and by following the instructions on the LCD. The user can observe the DAC output ( $V_{OUT}$ ) changes using an oscilloscope or voltmeter by pressing the S4 switch. The firmware provided is an example that can be used as reference for the user's applications.

## 1.5 CONNECTING TO THE EXPLORER 16 STARTER KIT

1. Connect the MCP47X6 PICtail™ Plus Daughter Board to the J5 socket on the Explorer 16 Development Board as shown in Figure 1-2.



**FIGURE 1-2:** Connecting the MCP47X6 PICtail™ Plus Daughter Board to the Explorer 16 Development Board.

### 1.5.1 Programming the PIC24FJ128 MCU

The Explorer 16 Development Board contains the PIC24FJ128 MCU. The user can download the firmware to the MCU using the MPLAB ICD2 (or ICD3) programmer.

#### 1.5.1.1 THE PIC24FJ128 MCU FIRMWARE FOR THE MCP47X6 PICtail™ PLUS DAUGHTER BOARD

The original firmware for the Explorer 16 Development Board is modified for the MCP47X6 PICtail™ Plus Daughter Board demonstration. The firmware uses most of the original code for the Explorer 16 Development Board except the I<sup>2</sup>C peripheral control routines for the PIC24FJ128 MCU.

The following four routines are added or modified from the original Explorer 16 Development Board firmware:

- PIC24ExplDemo\_MCP4726\_Main.c
- MCP47x6\_I2C\_Func.c
- Banner\_MCP4726\_MCP4716\_MCP4706.c
- I2C\_MCP4726.h

The source codes are compiled by using Microchip's C30 Compiler and the hex code is programmed to the MCU using the MPLAB ICD 2. Figure 1-3 shows the connection between the MPLAB ICD 2 and the Explorer 16 Development Board. Figure 1-4 shows the MPLAB IDE programming environment.

# MCP47X6 PICtail™ Plus Daughter Board User's Guide

## 1.5.1.2 FIRMWARE FLOW CHART FOR THE MCP47X6 PICtail™ PLUS DAUGHTER BOARD

Figure 1-5 shows the flow chart of the firmware. Once the MCU firmware is programmed, the LCD will display instructions (with repeats) for the next steps. The firmware uses four push button switches on the Explorer 16 Development Board. The features of the switches are:

- S3: Selecting MCP4726 (12-bit DAC). MCP4726 Output is available at  $V_{OUT\ 1}$
- S6: Selecting MCP4716 (10-bit DAC). MCP4716 Output is available at  $V_{OUT\ 2}$
- S5: Selecting MCP4706 (8-bit DAC). MCP4706 Output is available at  $V_{OUT\ 3}$
- S4: Incrementing the DAC code using a write command (writing both DAC register and EEPROM). The DAC output can be monitored at the  $V_{OUT}$  terminal. See Figure 1-6 for the  $V_{OUT}$  waveform.

The Buzzer is connected to the MCP4726 output through JP2. Please disconnect JP2 if you don't need audible sounds.

The firmware is interactive with push button switches. Table 1-3 shows the details of the switches that are used.

The user can switch to other devices by using the device selection push button switches (S3, S6 and S5) any time. The DAC output can be updated with the S4. The DAC's configuration bit settings that are used in the firmware are:

- Gain = 1x, Reference = Internal  $V_{DD}$

**TABLE 1-3: SWITCHES FOR THE FIRMWARE CONTROL**

Device	Device Selection Switch	Switch to increment the DAC Input Code	Output Terminal	Configuration Bit Settings
MCP4726 (12 bit DAC)	S3	S4	$V_{OUT\ 1}$	Gain = 1x, $V_{REF} = V_{DD}$
MCP4716 (10 bit DAC)	S6		$V_{OUT\ 2}$	
MCP4726 (8 bit DAC)	S5		$V_{OUT\ 3}$	

### 1.5.1.3 DAC OUTPUT ( $V_{OUT}$ )

The MCP47X6 PICtail™ Plus Daughter Board has three DAC output terminals for each DAC device.

- $V_{OUT\ 1}$ : Output from the MCP4726 (12-bit DAC)
- $V_{OUT\ 2}$ : Output from the MCP4716 (10-bit DAC)
- $V_{OUT\ 3}$ : Output from the MCP4706 (8-bit DAC)

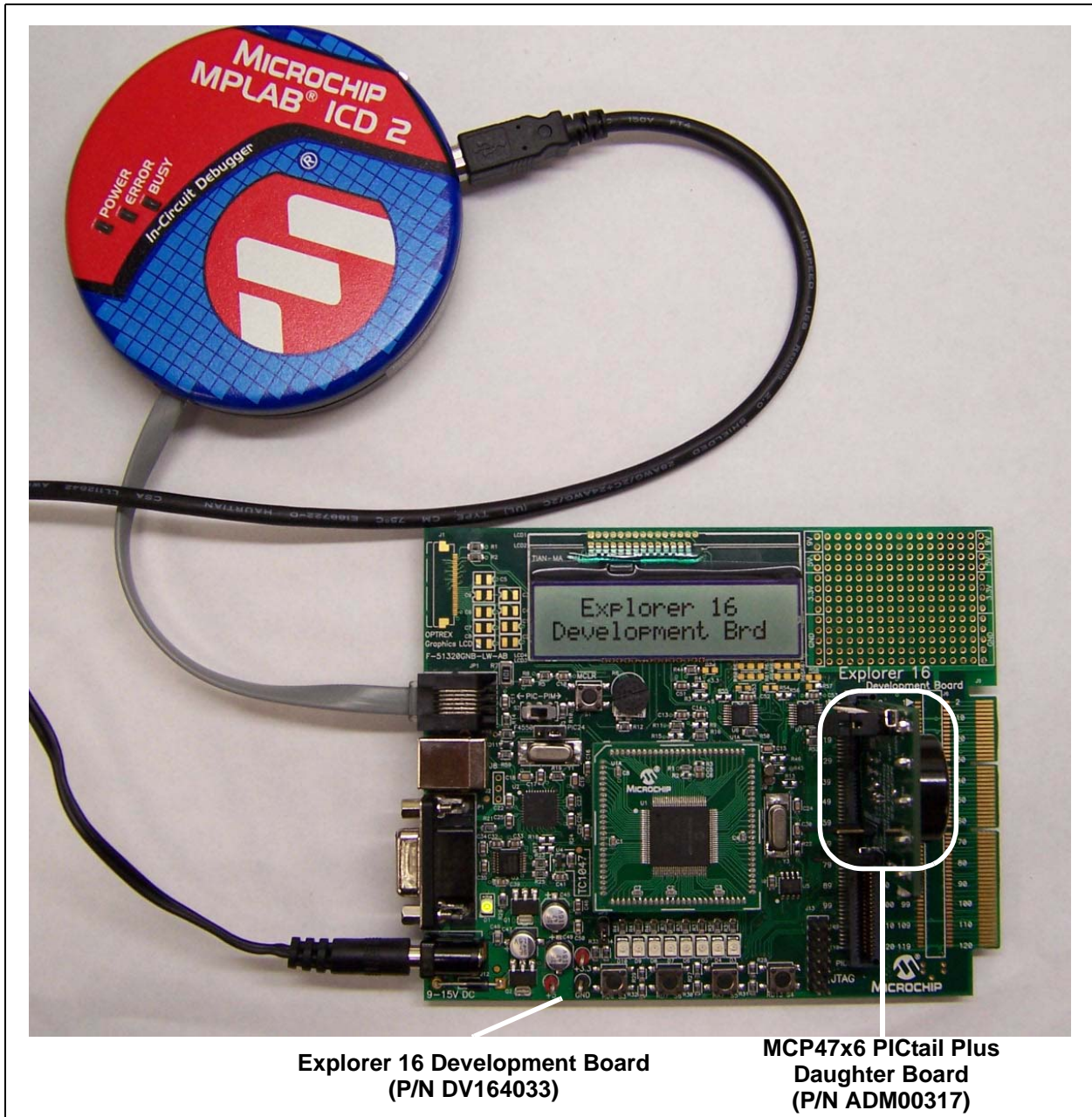
The user can observe the DAC outputs at the  $V_{OUT}$  test terminals using a digital voltmeter or an oscilloscope. Figure 1-7 shows the I<sup>2</sup>C clock (SCL) and data (SDA) signals, and DAC output waveform.

**Note:** The DAC code is also programmed in EEPROM. The DAC devices on the MCP47x6 Daughter Board will hold the latest settings when the power supply is removed. When power supply is back on again (Example: Remove the board from the Explorer 16 Development Board and connect again), the same DAC output voltage with the previous settings will be immediately available at the DAC output terminal.

# Quick Start Instructions

## 1.5.1.4 AUDIBLE BUZZER

The MCP47X6 PICtail™ Plus Daughter Board includes a buzzer. This buzzer is directly connected to the  $V_{OUT}$  of the MCP4726 (12-bit DAC). The user can disable the buzzer by disconnecting JP2. The buzzer volume also can be adjusted by VR1.



**FIGURE 1-3:** MPLAB ICD2 Connection to Explorer 16 Development Board with the MCP47X6 PICtail™ Plus Daughter Board for Programming.

# MCP47X6 PICtail™ Plus Daughter Board User's Guide

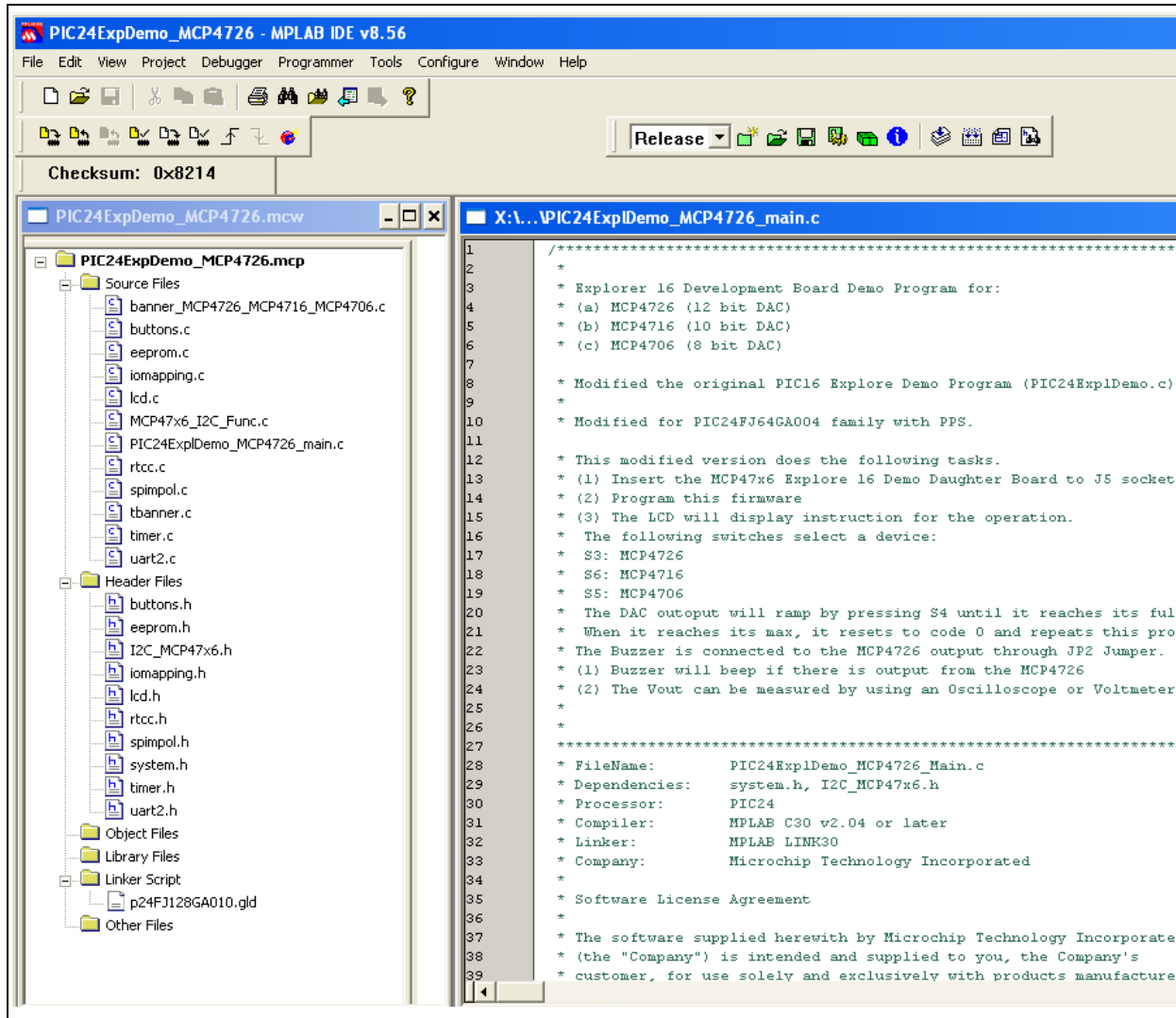
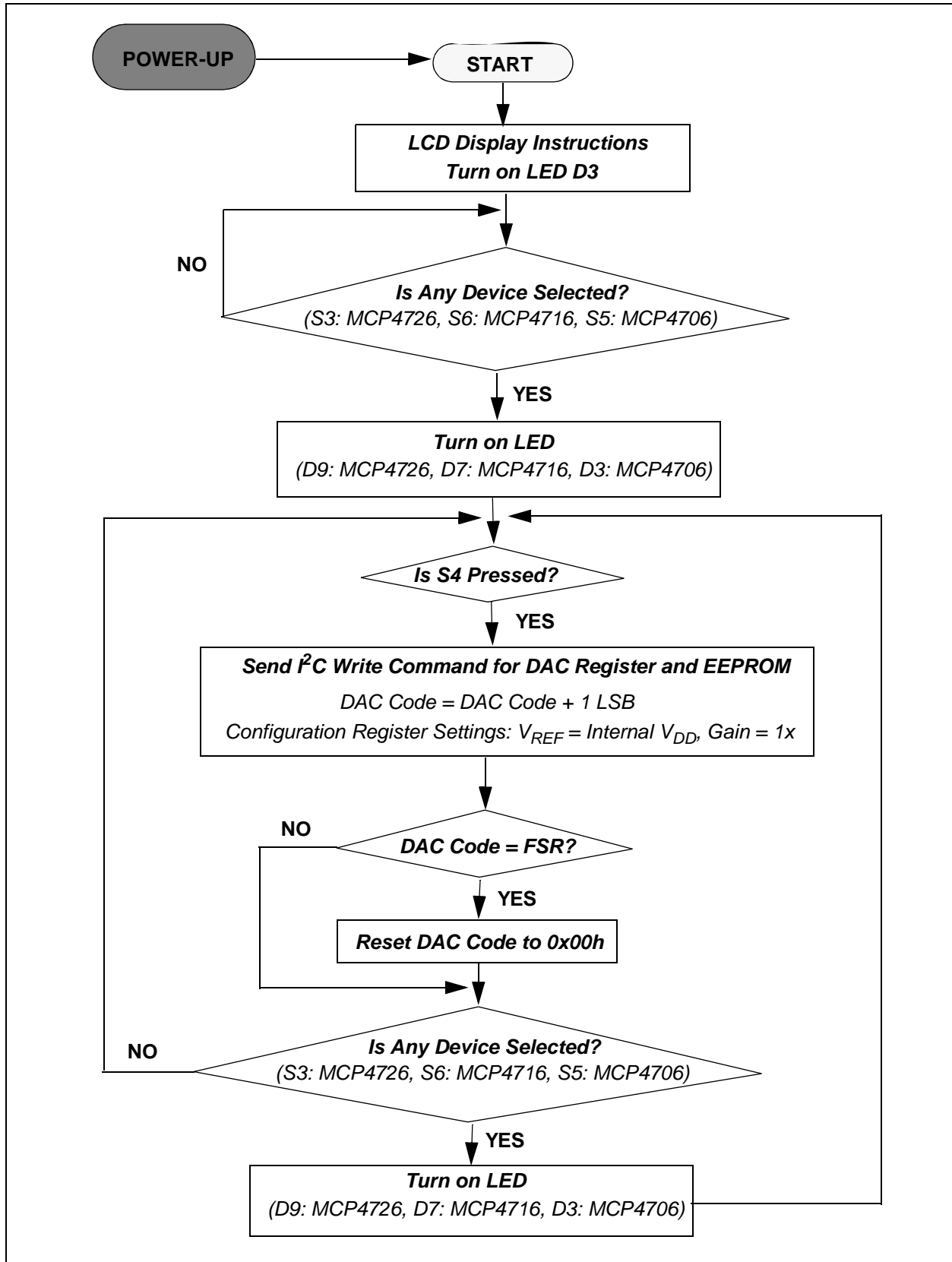


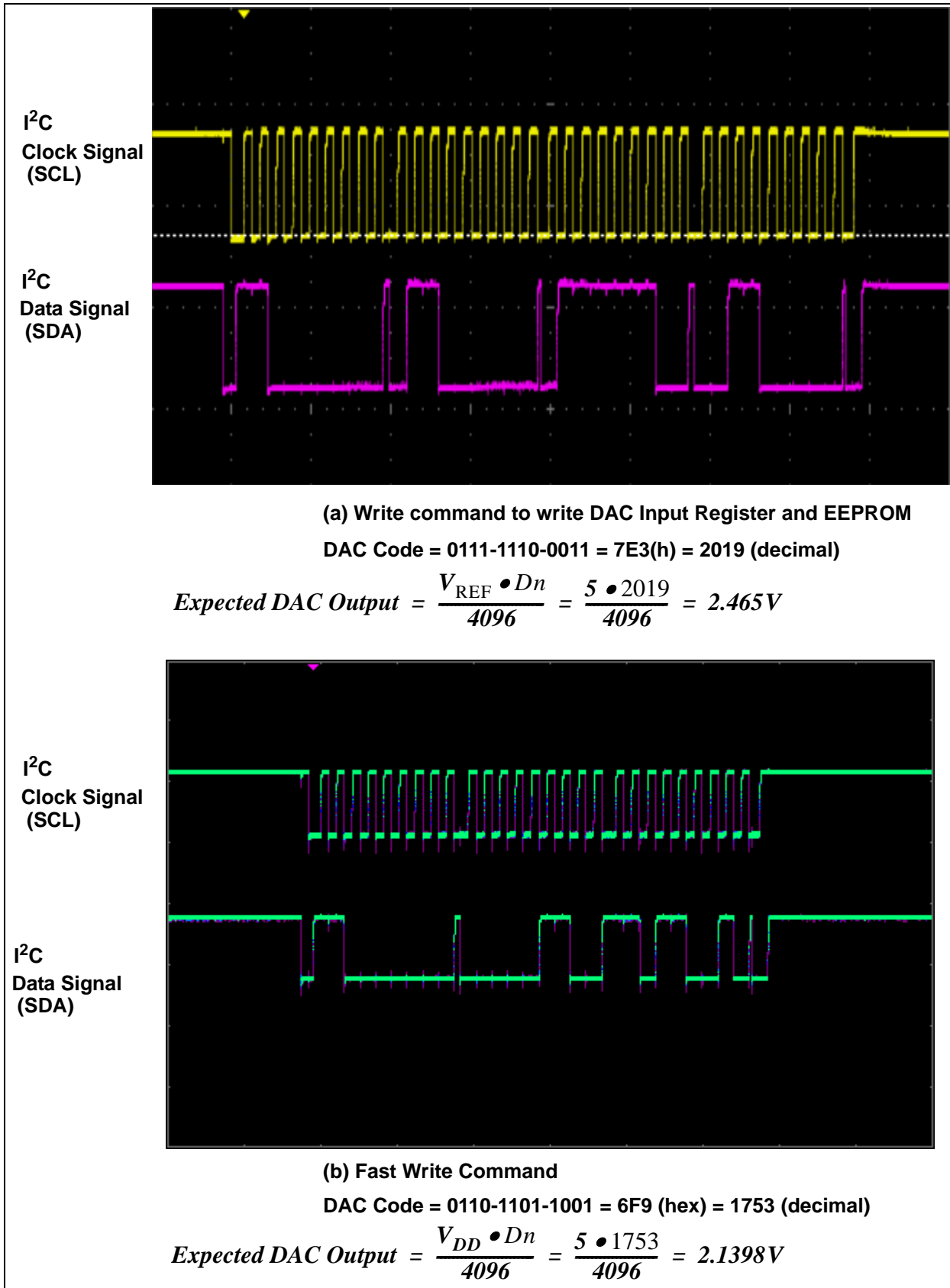
FIGURE 1-4: MPLAB IDE Programming Environment.



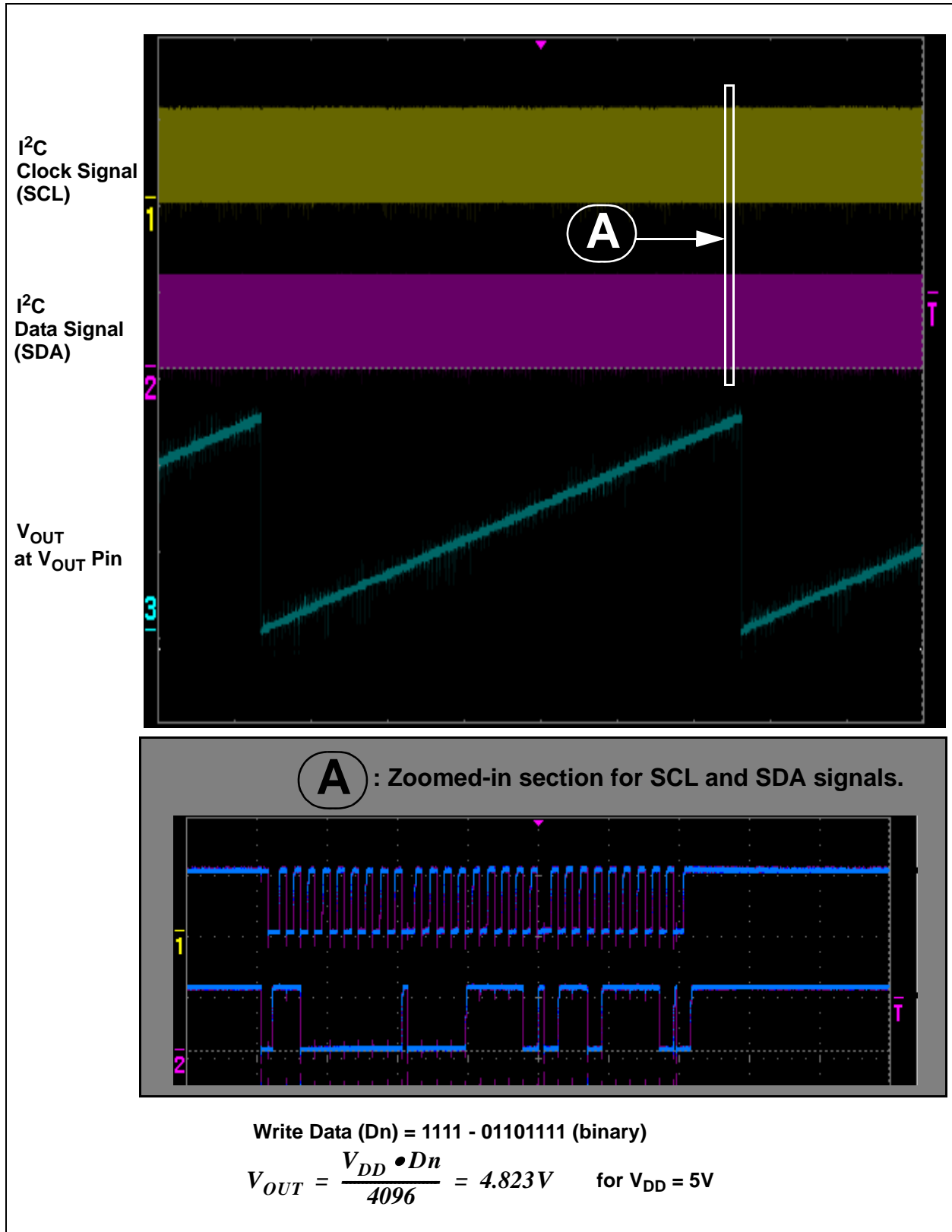


**FIGURE 1-5:** Flow Chart for the MCP47X6 PICtail™ Plus Daughter Board Firmware.

# MCP47X6 PICtail™ Plus Daughter Board User's Guide



**FIGURE 1-6:** I<sup>2</sup>C Write Command Waveforms for the MCP4726, with  $V_{REF} = V_{DD}$  and Gain = 1x.



**FIGURE 1-7:** I<sup>2</sup>C SCL, SDA, and V<sub>OUT</sub> Waveforms for the MCP4726 While Incrementing the DAC Code by 1 LSB. The Fast Write Command is Used for this Example.

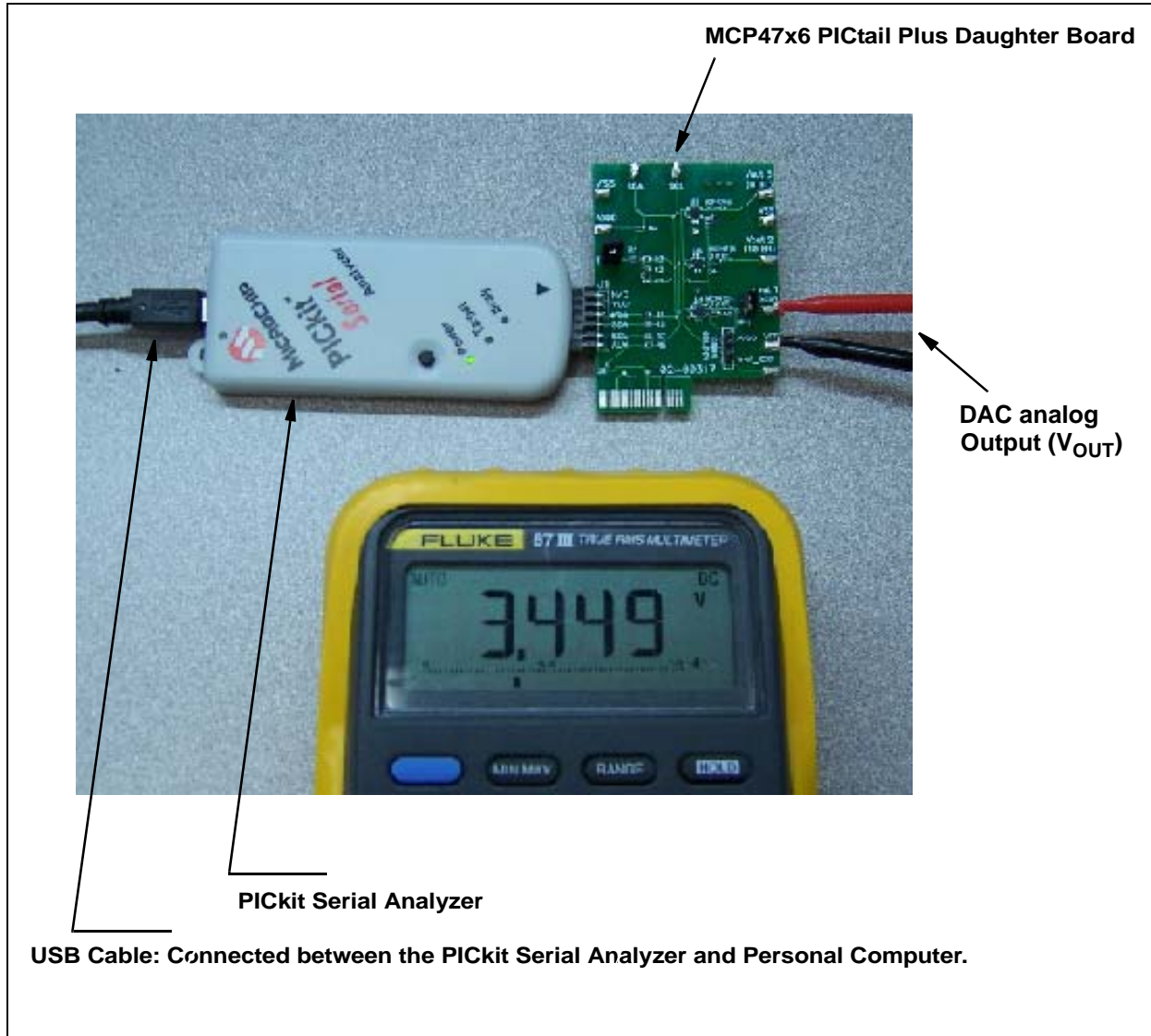
# MCP47X6 PICtail™ Plus Daughter Board User's Guide

## 1.6 GETTING STARTED WITH PICKIT™ SERIAL ANALYZER

The user can connect the MCP47X6 PICtail™ Plus Daughter Board to the PICKit™ Serial Analyzer by setting them up as shown in Figure 1-8.

The following describes how to use them together:

1. Connect the MCP47X6 PICtail™ Plus Daughter Board's J2 pin socket to the PICKit™ Serial Analyzer.
2. Connect a digital voltmeter to  $V_{OUT}$  test terminals and  $V_{SS}$ :
  - $V_{OUT}$  1 for MCP4726
  - $V_{OUT}$  2 for MCP4716
  - $V_{OUT}$  3 for MCP4706

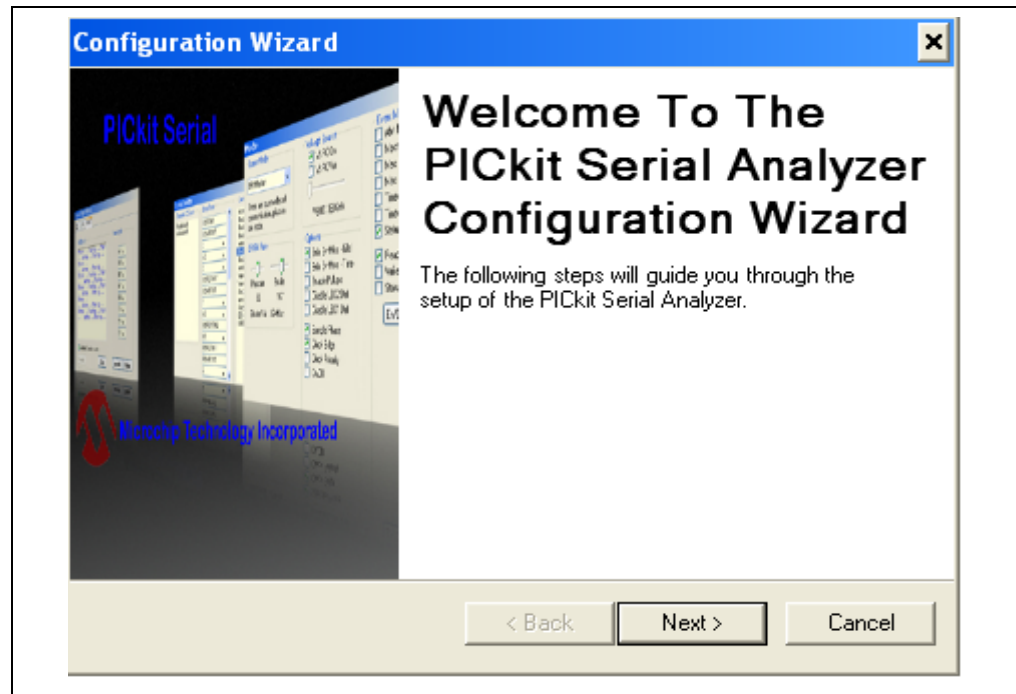


**FIGURE 1-8:** MCP47X6 PICtail™ Plus Daughter Board with the PICKit™ Serial Analyzer.

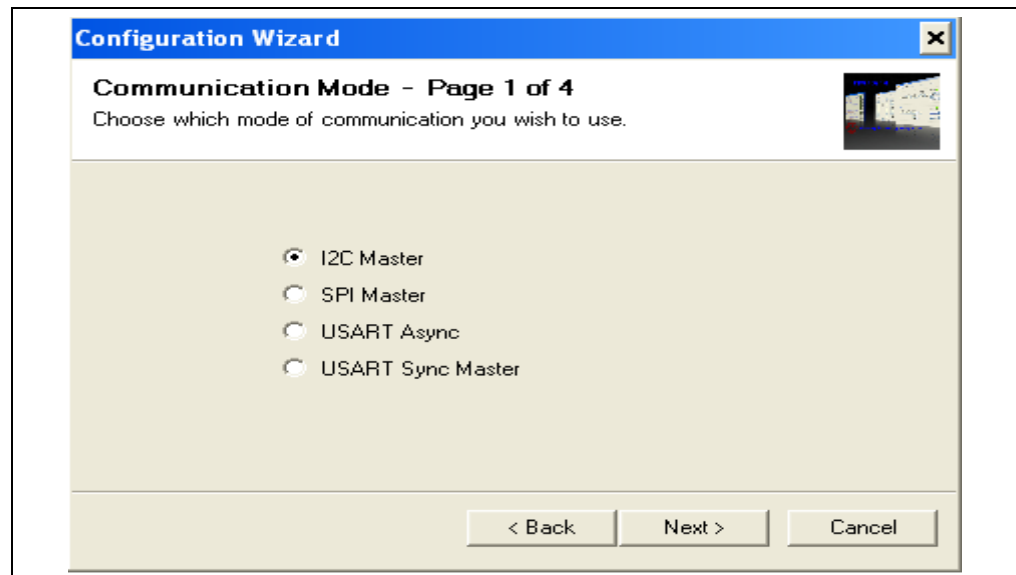
## 1.6.1 PICKit™ Serial Analyzer PC Software Set-Up for the MCP47x6 Daughter Board

The following steps describe how to set up and use the PICKit™ Serial Analyzer PC Graphic User Interface (GUI) to evaluate the MCP47X6 PICtail™ Plus Daughter Board.

1. Install the PICKit™ Serial Analyzer software onto your personal computer (PC).
2. Connect the USB cable between the PICKit™ Serial Analyzer and your PC.
3. Run the PICKit™ Serial PC Software. It will open up the graphic user interface (GUI) as shown. Click the **Next** button and follow the instructions.

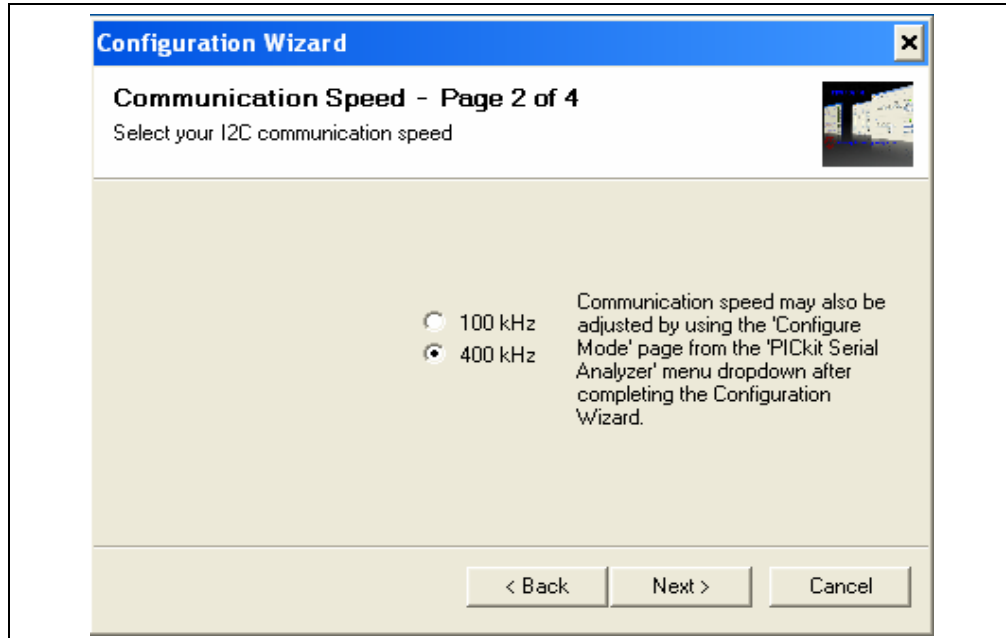


4. Select the Communication Mode type: I<sup>2</sup>C Master, and click the **Next** button.



# MCP47X6 PICtail™ Plus Daughter Board User's Guide

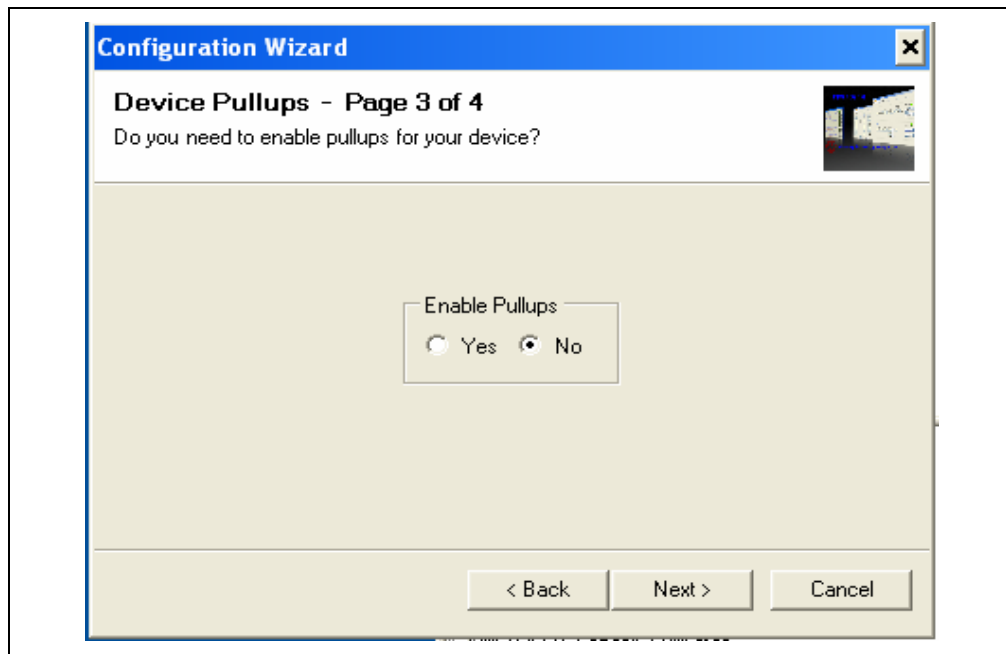
5. Select either 100 kHz or 400 kHz, and click the **Next** button.



**Note:** The MCP47x6 devices support the I<sup>2</sup>C bus data rate up to 3.4 MHz, but the current version of the PICkit™ Serial Analyzer supports the I<sup>2</sup>C bus data rate up to 400 kHz only.

6. Select No on Enable Pull-ups, and click the **Next** button.

**Note:** The MCP47X6 PICtail™ Plus Daughter Board has its own pull-up resistors, therefore, you don't need additional pull-up resistors from the PICkit™ Serial Analyzer.



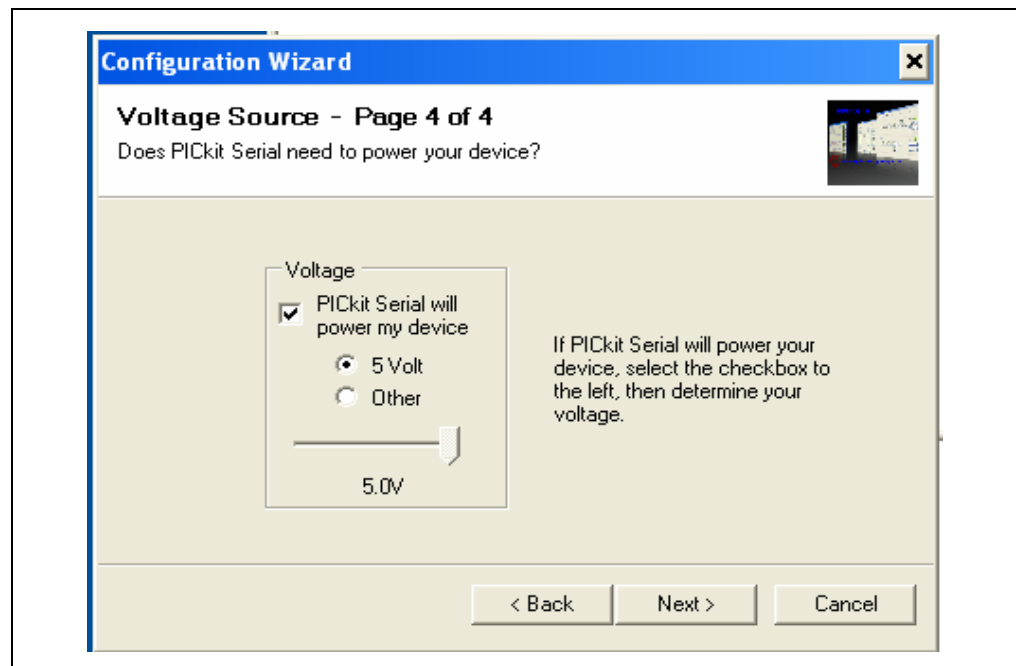
7. Select the  $V_{DD}$  voltage of the MCP47X6 PICtail™ Plus Daughter Board and click the **Next** button.

## Case 1: When you use $V_{DD}$ from the PICkit™ Serial Analyzer

If you choose **PICkit™ Serial will power my device** and **5 Volts** as shown below, the MCP47X6 PICtail™ Plus Daughter Board is powered by the 5V DC (range between 4.85V ~ 5V) from the PICkit™ Serial Analyzer through the JP1 jumper. In this case, make sure that the JP1 jumper on the MCP47X6 PICtail™ Plus Daughter Board is connected.

## Case 2: When you use your own $V_{DD}$

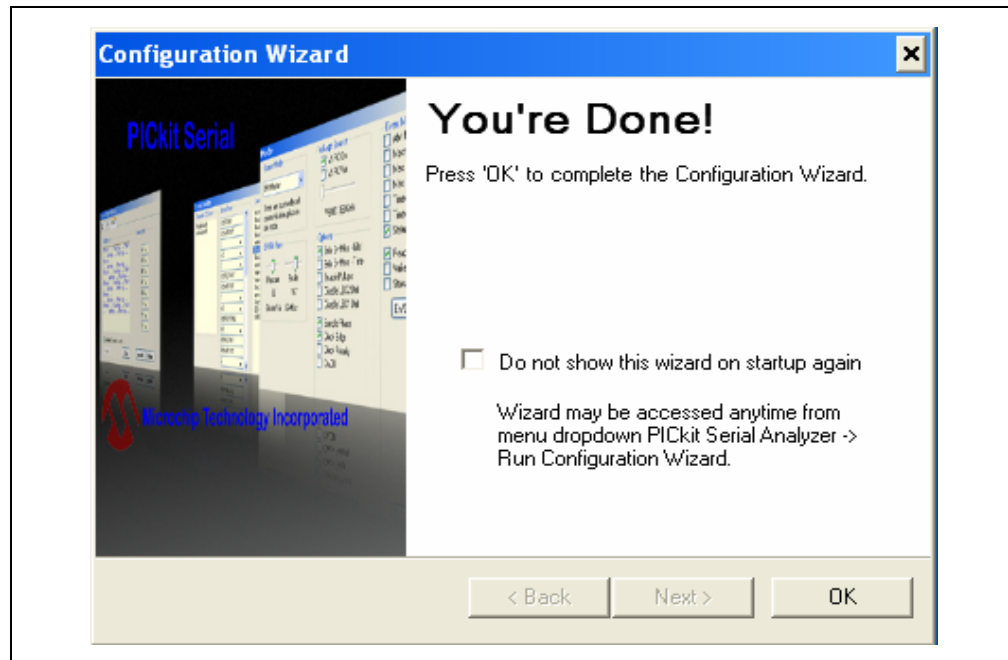
You can also provide your own  $V_{DD}$  voltage by applying a  $V_{DD}$  voltage at the  $V_{DD}$  terminal. In this case, make sure that the JP1 jumper is disconnected.



# MCP47X6 PICtail™ Plus Daughter Board User's Guide

---

8. Click the **OK** button. You have made all of the PICkit™ Serial Analyzer Configuration set-ups. You are now ready to program the MCP47X6 PICtail™ Plus Daughter Board using the PICkit™ Serial Analyzer.

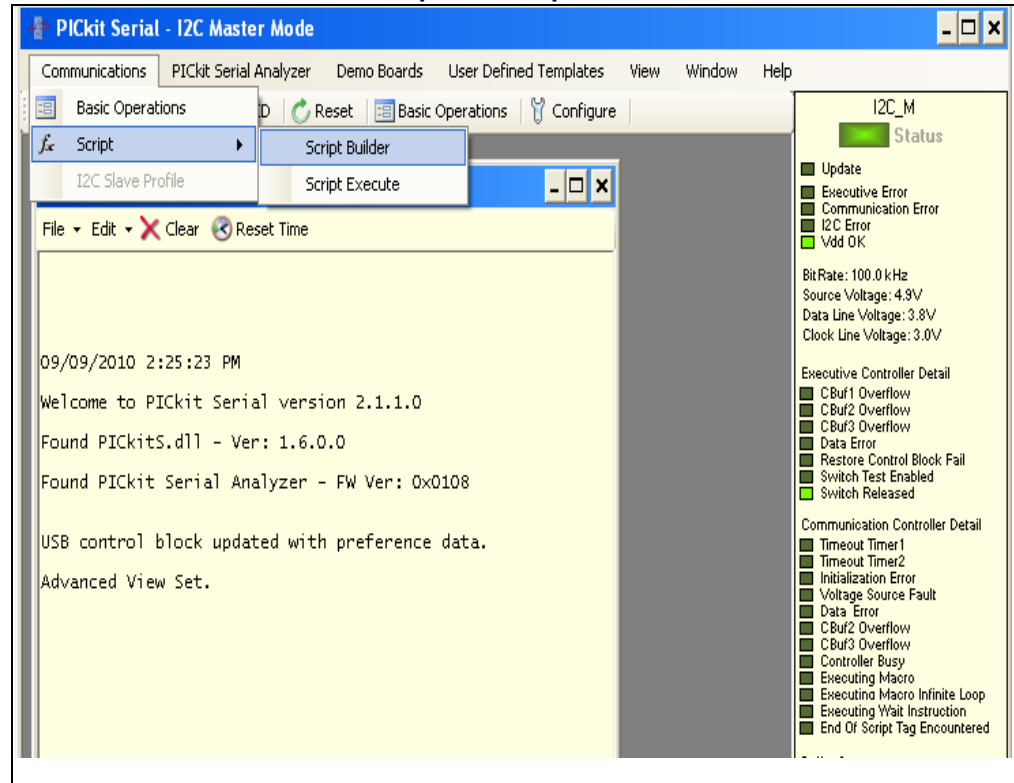




## 1.6.2 Creating Script Files

In order to create a communication between the PICKit™ Serial Analyzer and the MCP47X6 PICtail™ Plus Daughter Board, a script file is needed. The following procedure shows how to create script files and how to use them.

Select **Communication** -----> **Script** ---> **Script Builder**.



**Note:** The MCP47X6 scripts are in a text file on the MCP47X6 PICtail™ Plus Daughter Board's product web page. The scripts can be copied into the PICKit™ serial's CommScripts.txt file.

# MCP47X6 PICtail™ Plus Daughter Board User's Guide

## 1.6.2.1 CREATING SCRIPT FILES TO PROGRAM DAC REGISTER AND EEPROM

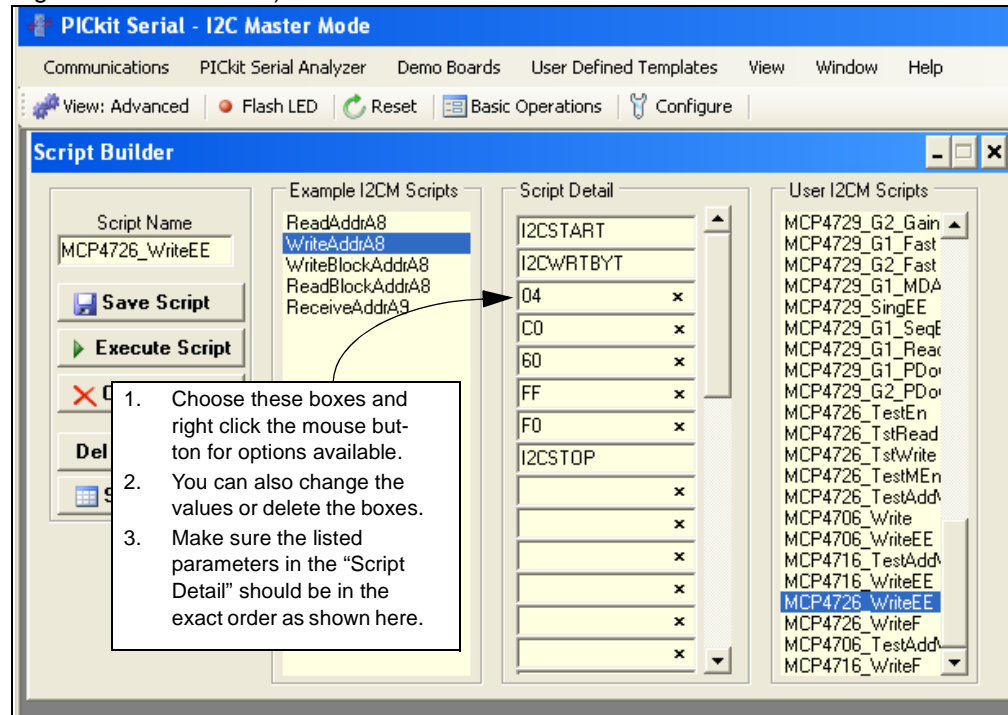
1. Click on **WriteBlockAddrA8** in “Example I2C Scripts” column.

This will fill in the spaces under **Script Detail** column.

### Modifying the Script Details Parameters:

2. Under the **Script Detail** column, select the item in the parameter box.
3. Right click the mouse button and an option box appears to the right of your selection. This gives you the options that are available for the parameter selected. Select the desired option.
4. Keep the parameters in the same order as shown below.

The following example shows how to create a script file for a Write command (DAC register and EEPROM) for the MCP4726.



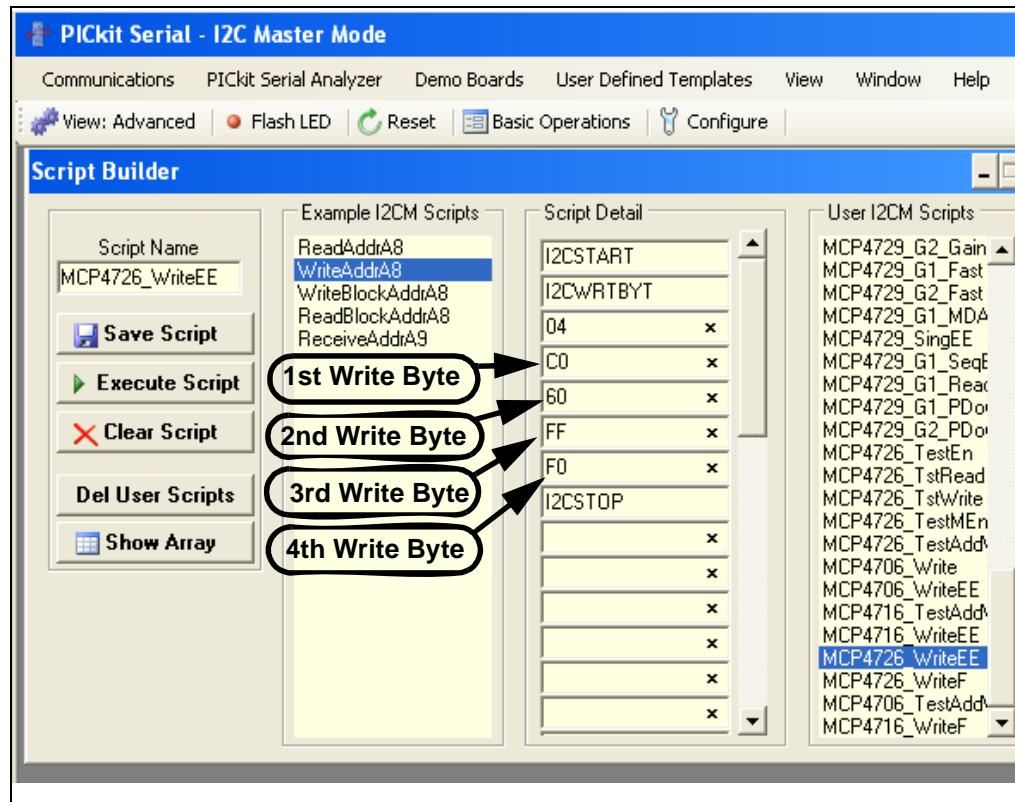
4. Change the parameter value.

Script Detail	
I2CSTART	*
I2CWRTBYT	*
04	----> This means there are four bytes to send
C0	----> 1st Write Byte: Address byte = 1100-0000
60	----> 2nd Write Byte: 1100-0000 (Command + Config.)
FF	----> 3rd Write Byte: 1111-1111 (Data Byte)
F0	----> 3rd Write Byte: 1111-0000 (Data Nibble +Don't care Nibble)
I2CSTOP	*

**Note:** All the 8 parameters above must be listed in order. The parameters with \* are not modifiable. Address bits for the MCP4726 is (A2, A1, A0) = (0, 0, 0). You can choose any data bit you want in the 3rd and 4th bytes. If you use the above write data, the MCP4726 device will output:

$$V_{OUT} = \frac{V_{DD} \cdot FFF(hex)(V)}{4096} = V_{DD} (V)$$

# Quick Start Instructions



## 1.6.2.2 SAVING THE SCRIPT FILE AND PROGRAMMING DAC REGISTER (WRITING BOTH DAC REGISTER AND EEPROM)

1. Change the 3rd and 4th data bytes, if desired, in the **Script Detail** column.
2. Type in any script name (i.e., MCP4726\_WriteEE) in the space below the **Script Name** menu.
3. Click **Save Script** button.
4. Click **Execute Script** button.

**Note:** At this point, the PICkit™ Serial transmits a write command of “Write DAC Register and EEPROM” to the MCP4726 device (address = 000). The saved file name will appear in **Users I2C Scripts** column and can be reused at any time by selecting the file name.

5. The analog output voltage of the MCP4726 will be monitored at  $V_{OUT1}$  terminal on the Daughter Board.

**Note:** When you click on the “Execute Script” menu, the “Busy” LED on the PICkit Serial Analyzer will momentarily turn on and then turn off. If the LED remains ON, a communications problem has occurred. Remove the PICkit Serial Analyzer from the personal computer and recheck the parameter value in the order of the parameters under the **Script Detail** column. Try again until the “Busy” LED goes OFF after executing the write command.

# MCP47X6 PICtail™ Plus Daughter Board User's Guide

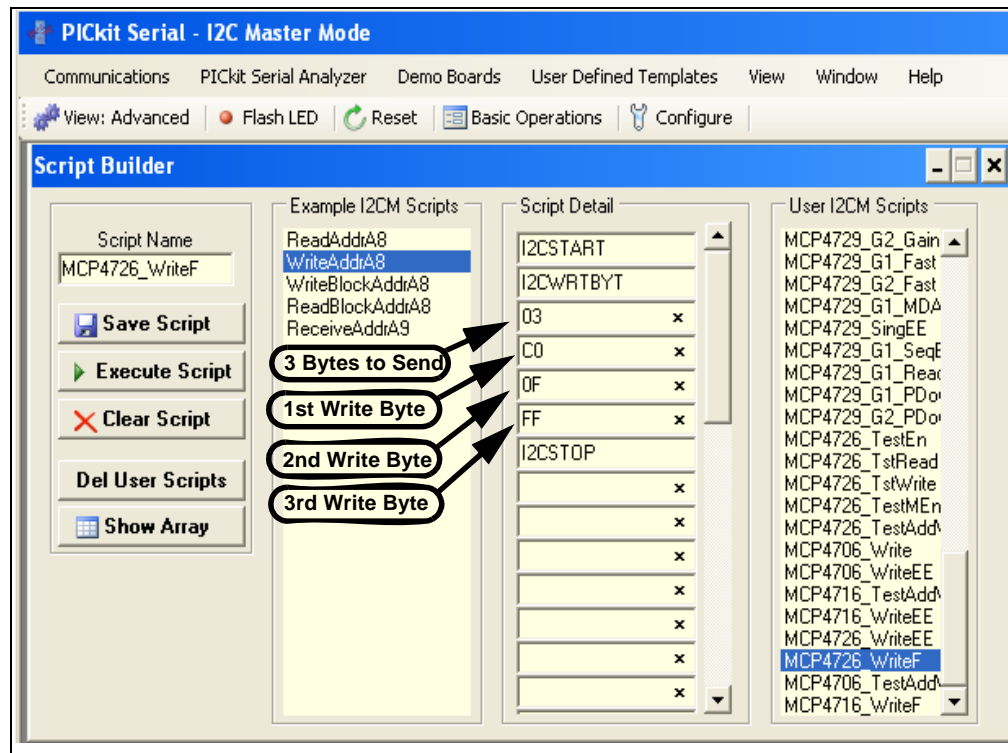
## 1.6.2.3 CREATING A SCRIPT FILE TO PROGRAM THE DAC REGISTER WITH FAST MODE COMMAND

1. Get a new script file by selecting the **WriteAddrA8** from the “Example I2C Scripts” column.
2. Modify the **Script Detail** column as shown below:

Script Detail	
I2CWRTBYT	*
I2CSTART	*
03	-----> This means Master will send three bytes
C0	-----> 1st Write Byte: Address byte = 1100-0000
0F	-----> 2nd Write Byte: 0000-FFFF (Data Byte)
FF	-----> 3rd Write Byte: FFFF-FFFF (Data Nibble + Don't care Nibble)
I2CSTOP	*

$$\text{Now the device will output } V_{OUT} = \frac{V_{DD} \cdot D_n}{4096} = \frac{5V \cdot 800(\text{hex})}{4096} = 2.5V$$

3. Type in the script name (i.e., **MCP4726\_WriteF**) in the space below the **Script Name** menu.
4. Click the **Execute Script** button.



## 1.6.3 Verifying the EEPROM Data

One of the important features of the MCP4706 devices is the nonvolatile memory. When the device is first powered up, it outputs an analog voltage corresponding to the data in the EEPROM. The user can confirm this feature using the following procedures:

1. Program the EEPROM memory. Refer to [Section 1.6.2.1 “Creating Script Files to Program DAC Register and EEPROM”](#).
2. Remove power ( $V_{DD}$ ) from the MCP47X6 PICtail™ Plus Daughter Board, or remove the daughter board from the PICKit™ Serial Analyzer.
3. Reconnect power ( $V_{DD}$ ) to the Daughter Board or reconnect the Daughter Board to the PICKit™ Serial Analyzer.
4. You can confirm that the programmed DAC output at the DAC output terminal ( $V_{OUT\ 1}$ ,  $V_{OUT\ 2}$ ,  $V_{OUT\ 3}$ ) by using a digital voltmeter.

## 1.6.4 Reading both the DAC Register and EEPROM data:

You can read back the DAC code stored in the DAC register and EEPROM with the following steps:

1. Create a read command script file name as shown below and execute it.
2. The results (DAC code and EEPROM data) will appear on the PICKit™ Serial Transactions page.

# MCP47X6 PICtail™ Plus Daughter Board User's Guide

**PICkit Serial - I2C Master Mode**

Communications    PICkit Serial Analyzer    Demo Boards    User Defined Templates    View    Window    Help

View: Advanced    Flash LED    Reset    Basic Operations    Configure

**Script Builder**

Script Name: MCP4726\_Read

Save Script    Execute Script    Clear Script    Del User Scripts    Show Array

Example I2CM Scripts:

- ReadAddrA8
- WriteAddrA8
- WriteBlockAddrA8
- ReadBlockAddrA8
- ReceiveAddrA9

Script Detail:

I2CSTART	
I2CWRTBYT	
01	x
C1	x
I2CRDDBYTNLB	
06	x
I2CSTOP	
	x
	x
	x
	x
	x
	x
	x

User I2CM Scripts:

- MCP4729\_G2\_Gain
- MCP4729\_G1\_Fast
- MCP4729\_G2\_Fast
- MCP4729\_G1\_MDA
- MCP4729\_SingEE
- MCP4729\_G1\_Seql
- MCP4729\_G1\_Rear
- MCP4729\_G1\_PD0
- MCP4729\_G2\_PD0
- MCP4726\_TestEn
- MCP4726\_TestWrite
- MCP4726\_TestMEen
- MCP4726\_TestAdd
- MCP4706\_Write
- MCP4706\_WriteEE
- MCP4716\_TestAdd
- MCP4716\_WriteEE
- MCP4726\_WriteEE
- MCP4726\_WriteF
- MCP4706\_TestAdd
- MCP4716\_WriteF
- MCP4726\_Read

**Transactions**

File    Edit    Clear    Reset Time

4:33:00 PM  
[S\_] [W\_] [04] [C0] [60] [FF] [F0] [P\_]

[S\_] [P\_]

4:33:12 PM  
[S\_] [W\_] [01] [C1] [RN] [06] [P\_]

[S\_] [C0] [FF] [F0] [E0] [FF] [F0] [P\_]

Written Data using a Write Command

Reading Data using a Read Command

DAC Register Data (Configuration bits + DAC Code)

EEPROM Data (Configuration bits + DAC Code)

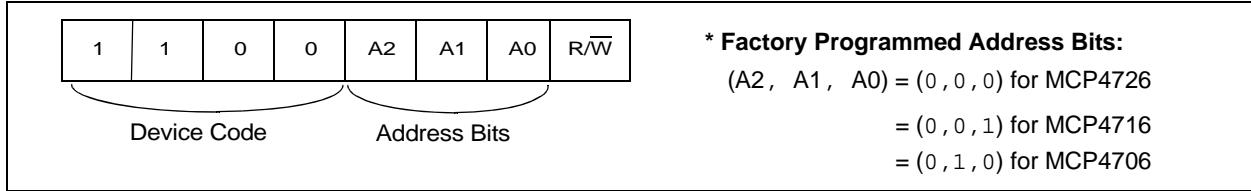
## 1.7 EXAMPLES FOR OTHER DEVICES (MCP4706, MCP4716)

The examples shown in the previous sections use the I<sup>2</sup>C address bits of the MCP4726 (A<sub>2</sub>, A<sub>1</sub>, A<sub>0</sub> = 0, 0, 0). The same procedure is also applicable for the remaining two devices (MCP4706, MCP4716) by simply using the right address byte for each device. Table 1-2 shows the address byte of each device. Refer to the MCP4706/MCP4716/MCP4726 Data Sheet for the data format of each command.

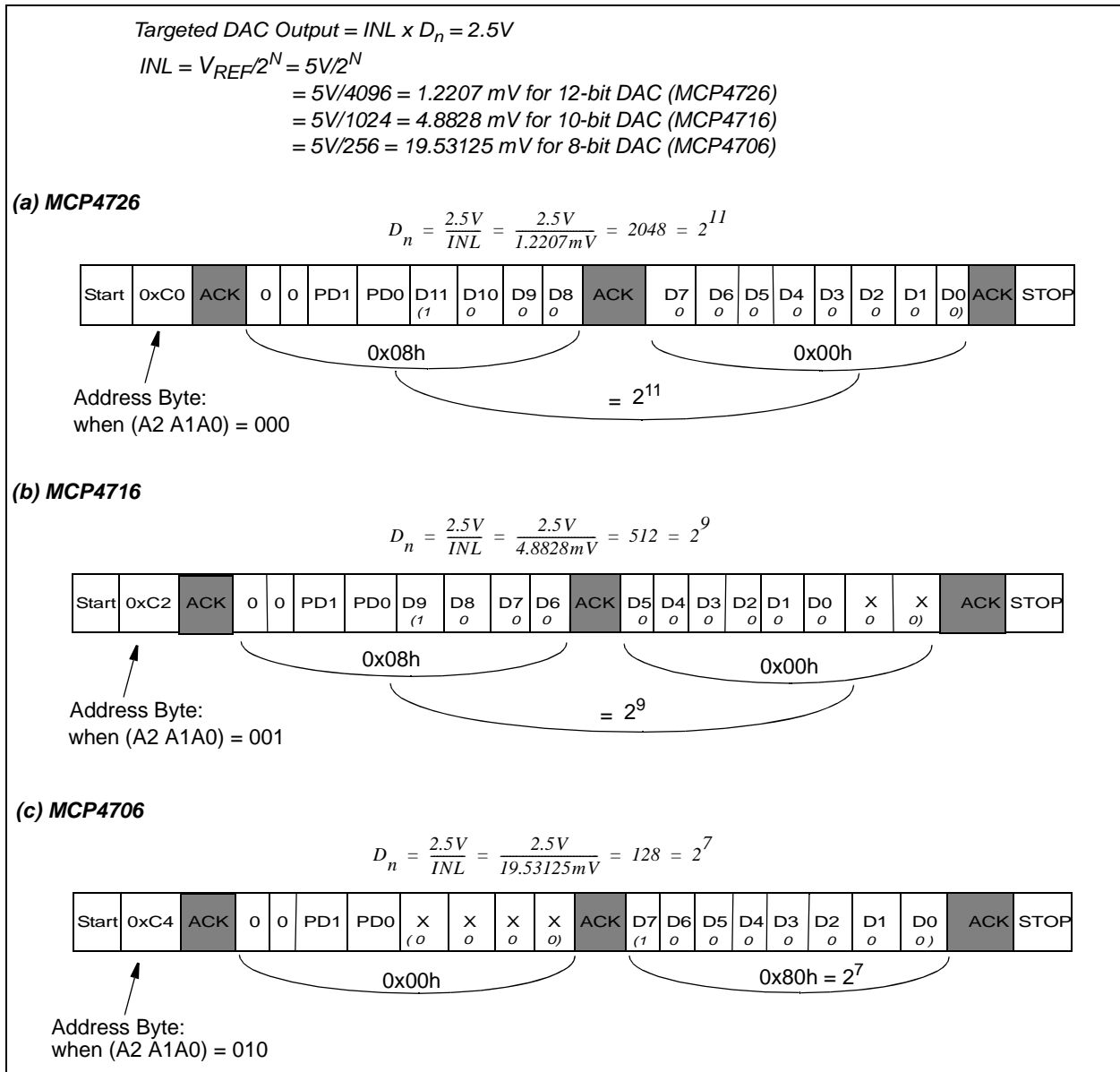
## 1.8 PROGRAMMING EXAMPLE USING THE PICKIT™ SERIAL ANALYZER

The following example shows how to set DAC code for the desired DAC output voltage using the Fast Write command.

See the MCP4706/MCP4716/MCP4726 Data sheet for more details on the data formats for each device.



**FIGURE 1-9:** MCP47x6 Device Address Byte.



**FIGURE 1-10:** Fast Mode Write Command for Targeted  $V_{OUT} = 2.5V$  when  $V_{REF} = 5V$ .

# MCP47X6 PICtail™ Plus Daughter Board User's Guide

---

NOTES:





# MCP47X6 PICtail™ PLUS DAUGHTER BOARD USER'S GUIDE

---

---

## Appendix A. Schematic and Layouts

---

---

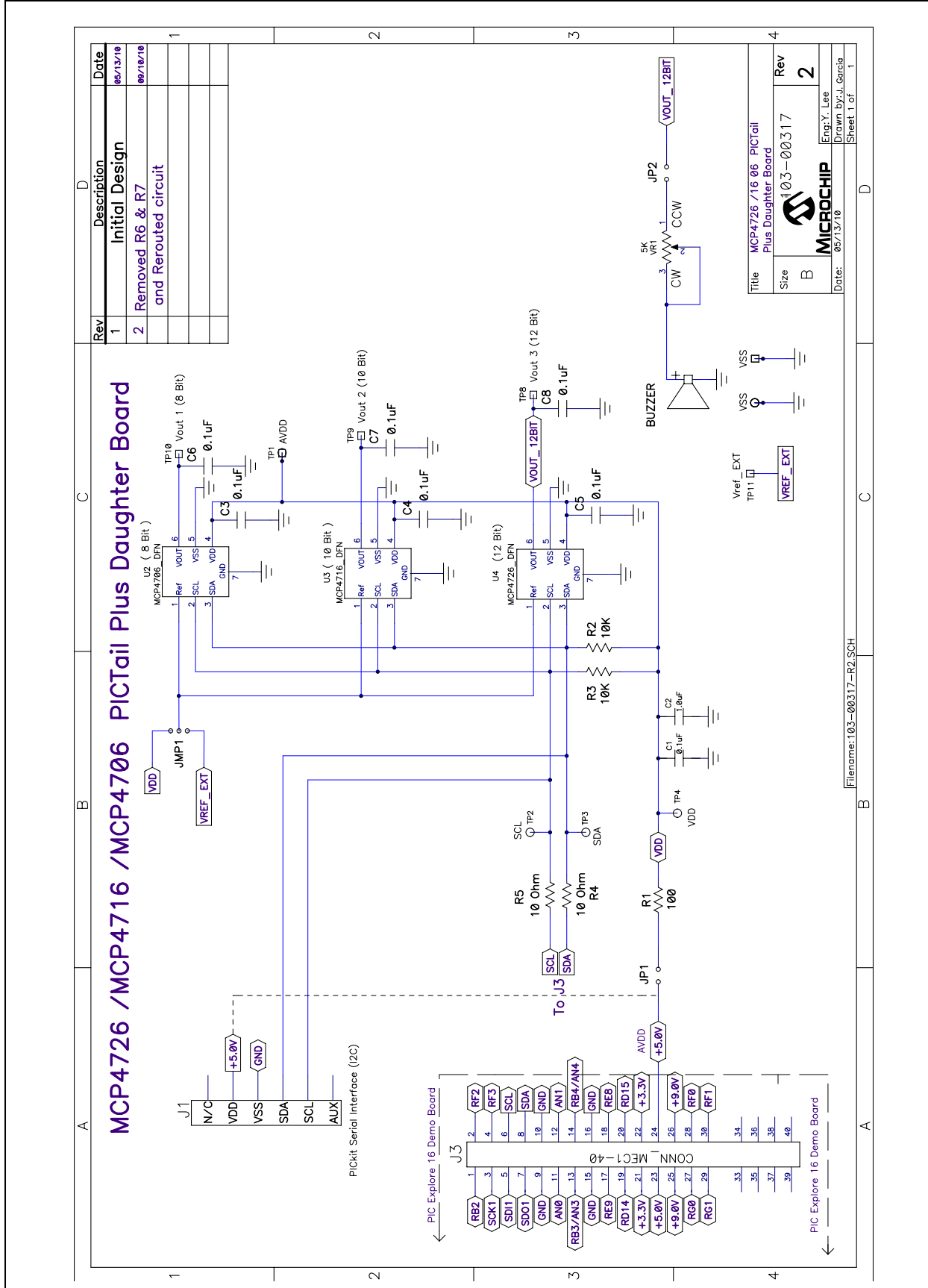
### A.1 INTRODUCTION

This appendix contains the following schematics and layouts for the MCP47x6 PICtail™ Plus Daughter Board:

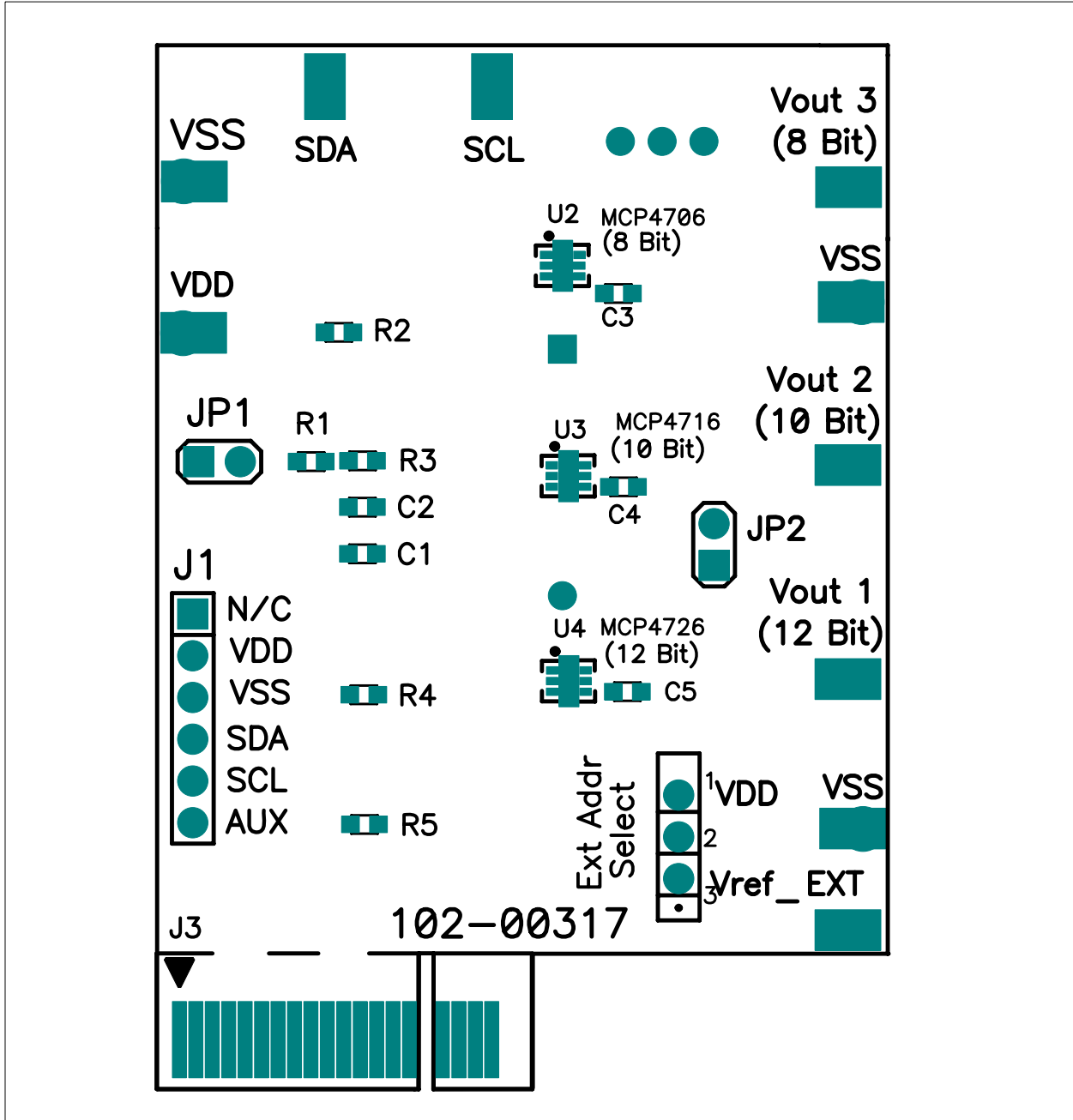
- Board – Schematic
- Board – Top Silk and Pads
- Board – Top Copper, Top Pads and Top Silk
- Board – Bottom Silk and Pads
- Board – Bottom Copper, Bottom Pads and Silk

# MCP47X6 PICtail™ Plus Daughter Board User's Guide

## A.2 BOARD – SCHEMATIC

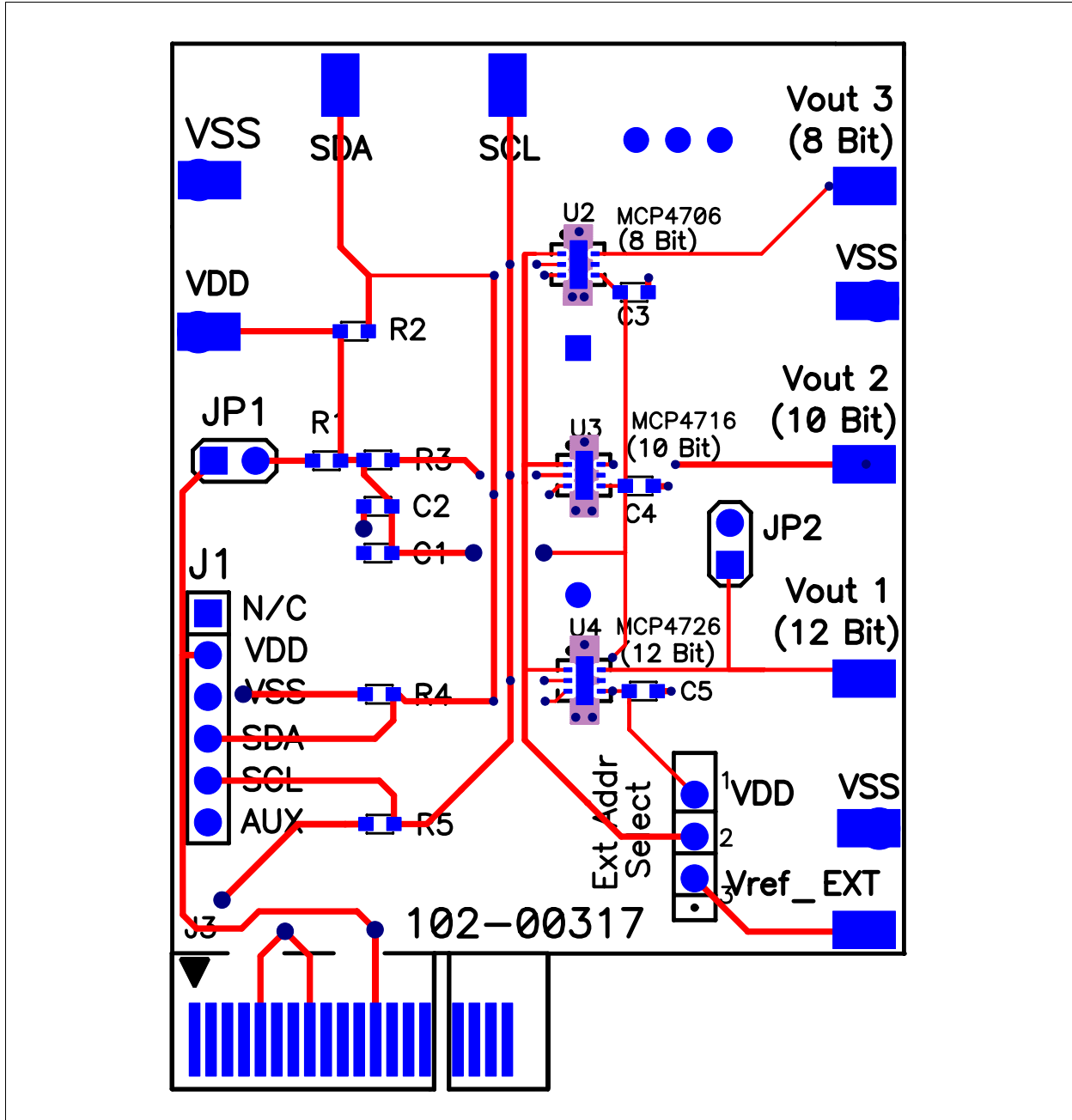


## A.3 BOARD – TOP SILK AND PADS

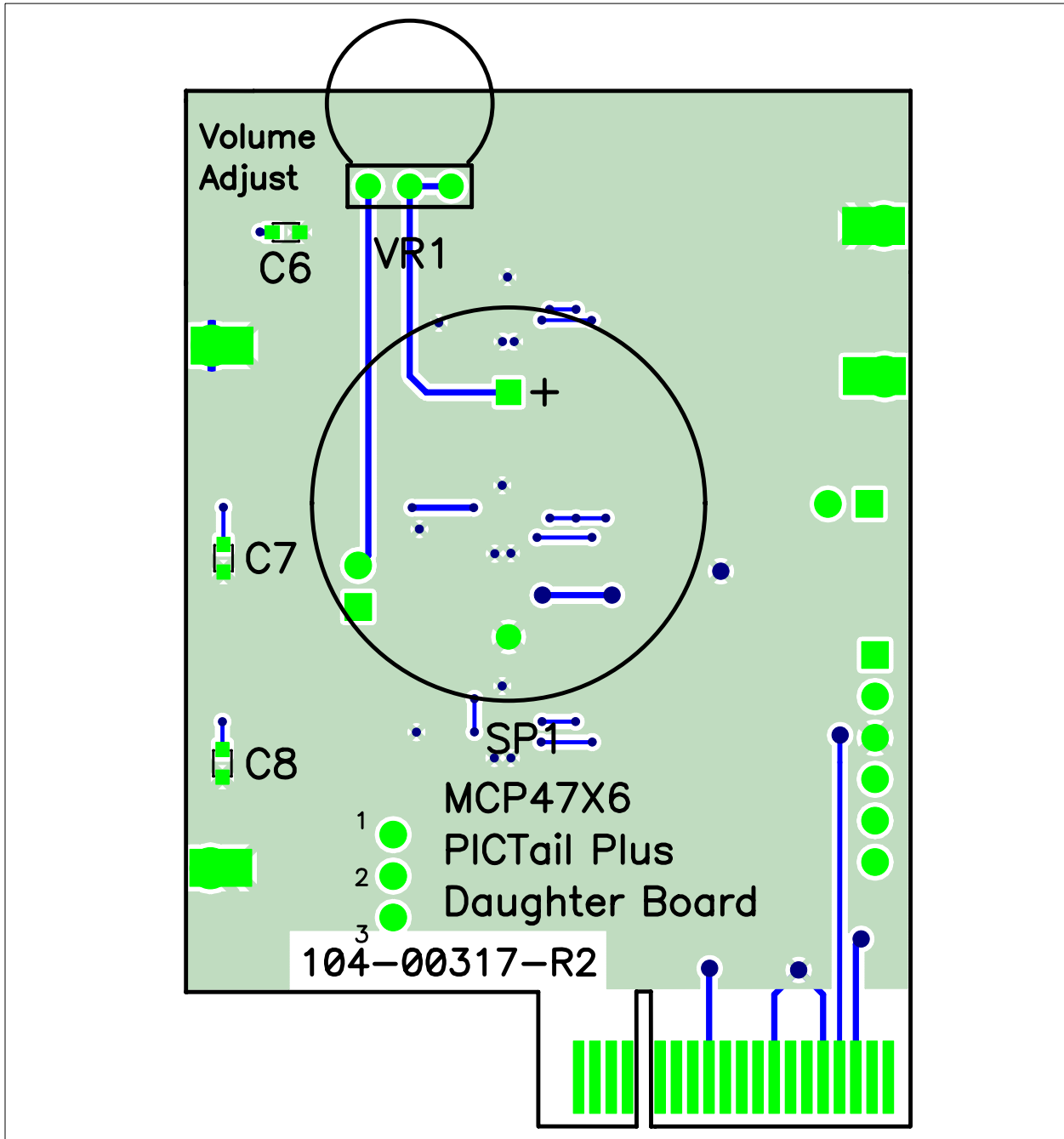


# MCP47X6 PICtail™ Plus Daughter Board User's Guide

## A.4 BOARD – TOP COPPER, TOP PADS AND TOP SILK

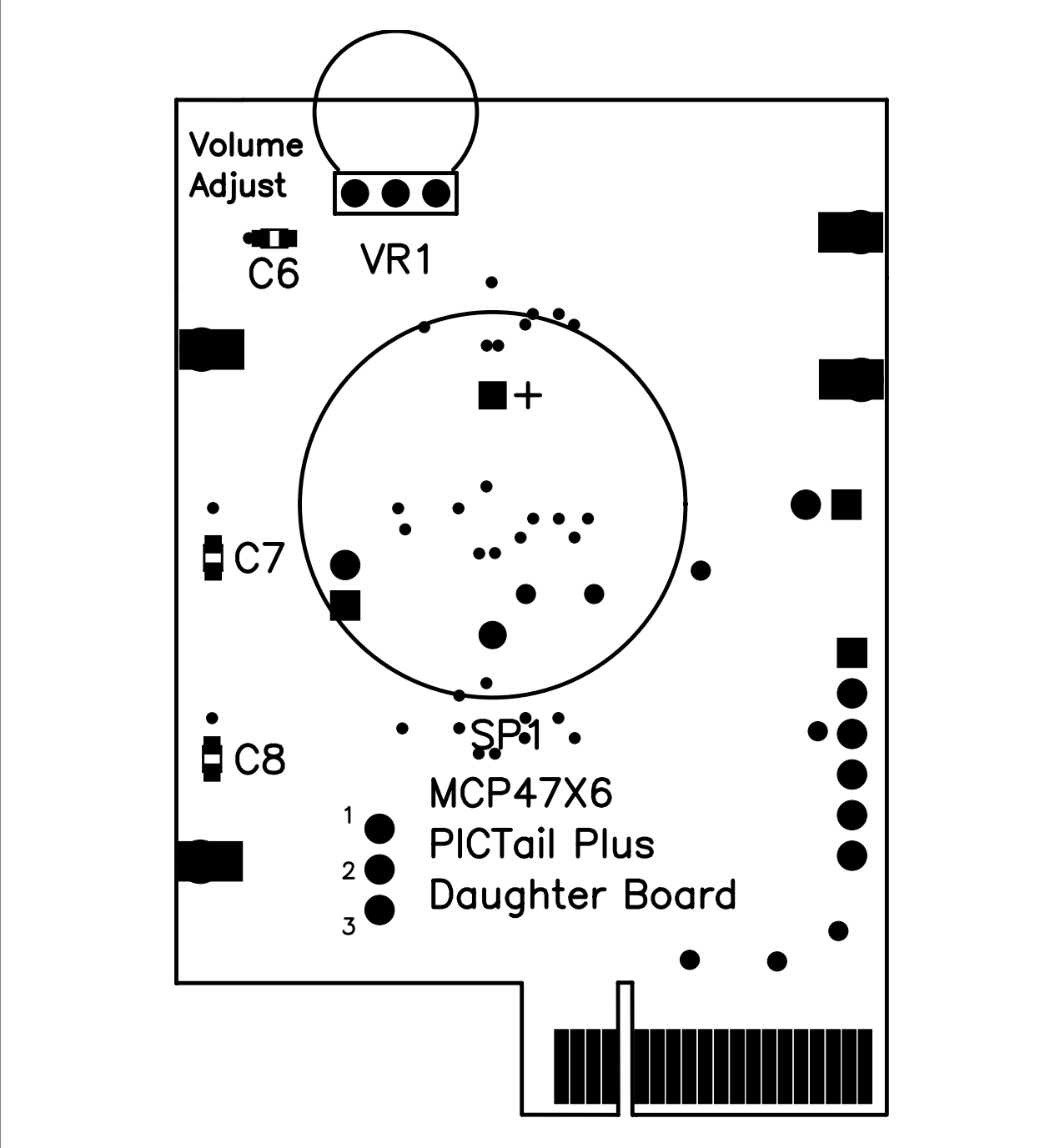


## A.5 BOARD – BOTTOM SILK AND PADS



# MCP47X6 PICTail™ Plus Daughter Board User's Guide

## A.6 BOARD – BOTTOM COPPER, BOTTOM PADS AND SILK





# MCP47X6 PICtail™ PLUS DAUGHTER BOARD USER'S GUIDE

## Appendix B. Bill Of Materials (BOM)

**TABLE B-1: BILL OF MATERIALS (BOM)**

Qty	Reference	Description	Manufacturer	Part Number
7	C1, C3, C4, C5, C6, C7, C8	CAP.1UF 16V CERAMIC X7R 0603	Panasonic - ECG	ECJ-1VB1C104K
1	C2	CAP 1.0UF 16V CERAMIC X5R 0603	Panasonic - ECG	ECJ-1VB1C105K
1	J1	CONN HEADER 6 POS. 100 R/A TIN	Molex/Waldom Electronics Corp	22-05-2061
1	JMP1	CONN HEADER 3 POS. 100" STR TIN	Molex/Waldom Electronics Corp	90120-0123
3	JMP1, JP1, JP2	SHUNT LP W/HANDLE 2 POS. 30AU *Bag shunts with kit*	Tyco Electronics/Amp	881545-2
2	JP1, JP2	CONN HEADER 2 POS. 100 VERT TIN	Molex/Waldom Electronics	22-03-2021
1	PCB	RoHS Compliant Bare PCB, MCP4726, MCP4716 MCP4706 PICtail™ Plus Daughter Board	-	104-00317
1	R1	RES 100 OHM 1/10W 1% 0603 SMD	Panasonic - ECG	ERJ-3EKF1000V
2	R2, R3	RES 10.0K OHM 1/10W 1% 0603 SMD	Panasonic - ECG	ERJ-3EKF1002V
2	R4, R5	RES 10 OHM 1/10W 5% 0603 SMD	Panasonic - ECG	ERJ-3GEYJ100V
1	U2	8-/10-/12-Bit Voltage Output Digital-to-Analog Converter with EEPROM	Microchip Technology Inc.	MCP4706A2T-E/MA
1	U3	8-/10-/12-Bit Voltage Output Digital-to-Analog Converter with EEPROM	Microchip Technology Inc.	MCP4716A1T-E/MA
1	U4	8-/10-/12-Bit Voltage Output Digital-to-Analog Converter with EEPROM	Microchip Technology Inc.	MCP4726A0T-E/MA
10	Vout1, Vout2, Vout3, VSS, EXT, VSS, SDA, SCL, VSS, AVDD	PC TEST POINT COMPACT SMT	Keystone Electronics	5016
1	VR1	POT 5.0K OHM THUMBWHEEL CERM ST	Bourns Inc.	3352T-1-502
1	SP1	BUZZER PIEZO 3kHz 24mm PIC MT	Mallory Sonalert Products, Inc.	PK-21N30PQ

**Note 1:** The components listed in this Bill of Materials are representative of the PCB assembly. The released BOM used in manufacturing uses all RoHS-compliant components.



# MICROCHIP

## Worldwide Sales and Service

### AMERICAS

**Corporate Office**  
2355 West Chandler Blvd.  
Chandler, AZ 85224-6199  
Tel: 480-792-7200  
Fax: 480-792-7277  
Technical Support:  
<http://www.microchip.com/support>  
Web Address:  
[www.microchip.com](http://www.microchip.com)

**Atlanta**  
Duluth, GA  
Tel: 678-957-9614  
Fax: 678-957-1455

**Boston**  
Westborough, MA  
Tel: 774-760-0087  
Fax: 774-760-0088

**Chicago**  
Itasca, IL  
Tel: 630-285-0071  
Fax: 630-285-0075

**Cleveland**  
Independence, OH  
Tel: 216-447-0464  
Fax: 216-447-0643

**Dallas**  
Addison, TX  
Tel: 972-818-7423  
Fax: 972-818-2924

**Detroit**  
Farmington Hills, MI  
Tel: 248-538-2250  
Fax: 248-538-2260

**Indianapolis**  
Noblesville, IN  
Tel: 317-773-8323  
Fax: 317-773-5453

**Los Angeles**  
Mission Viejo, CA  
Tel: 949-462-9523  
Fax: 949-462-9608

**Santa Clara**  
Santa Clara, CA  
Tel: 408-961-6444  
Fax: 408-961-6445

**Toronto**  
Mississauga, Ontario,  
Canada  
Tel: 905-673-0699  
Fax: 905-673-6509

### ASIA/PACIFIC

**Asia Pacific Office**  
Suites 3707-14, 37th Floor  
Tower 6, The Gateway  
Harbour City, Kowloon  
Hong Kong  
Tel: 852-2401-1200  
Fax: 852-2401-3431

**Australia - Sydney**  
Tel: 61-2-9868-6733  
Fax: 61-2-9868-6755

**China - Beijing**  
Tel: 86-10-8569-7000  
Fax: 86-10-8528-2104

**China - Chengdu**  
Tel: 86-28-8665-5511  
Fax: 86-28-8665-7889

**China - Chongqing**  
Tel: 86-23-8980-9588  
Fax: 86-23-8980-9500

**China - Hangzhou**  
Tel: 86-571-2819-3187  
Fax: 86-571-2819-3189

**China - Hong Kong SAR**  
Tel: 852-2401-1200  
Fax: 852-2401-3431

**China - Nanjing**  
Tel: 86-25-8473-2460  
Fax: 86-25-8473-2470

**China - Qingdao**  
Tel: 86-532-8502-7355  
Fax: 86-532-8502-7205

**China - Shanghai**  
Tel: 86-21-5407-5533  
Fax: 86-21-5407-5066

**China - Shenyang**  
Tel: 86-24-2334-2829  
Fax: 86-24-2334-2393

**China - Shenzhen**  
Tel: 86-755-8203-2660  
Fax: 86-755-8203-1760

**China - Wuhan**  
Tel: 86-27-5980-5300  
Fax: 86-27-5980-5118

**China - Xian**  
Tel: 86-29-8833-7252  
Fax: 86-29-8833-7256

**China - Xiamen**  
Tel: 86-592-2388138  
Fax: 86-592-2388130

**China - Zhuhai**  
Tel: 86-756-3210040  
Fax: 86-756-3210049

### ASIA/PACIFIC

**India - Bangalore**  
Tel: 91-80-3090-4444  
Fax: 91-80-3090-4123

**India - New Delhi**  
Tel: 91-11-4160-8631  
Fax: 91-11-4160-8632

**India - Pune**  
Tel: 91-20-2566-1512  
Fax: 91-20-2566-1513

**Japan - Yokohama**  
Tel: 81-45-471- 6166  
Fax: 81-45-471-6122

**Korea - Daegu**  
Tel: 82-53-744-4301  
Fax: 82-53-744-4302

**Korea - Seoul**  
Tel: 82-2-554-7200  
Fax: 82-2-558-5932 or  
82-2-558-5934

**Malaysia - Kuala Lumpur**  
Tel: 60-3-6201-9857  
Fax: 60-3-6201-9859

**Malaysia - Penang**  
Tel: 60-4-227-8870  
Fax: 60-4-227-4068

**Philippines - Manila**  
Tel: 63-2-634-9065  
Fax: 63-2-634-9069

**Singapore**  
Tel: 65-6334-8870  
Fax: 65-6334-8850

**Taiwan - Hsin Chu**  
Tel: 886-3-5778-366  
Fax: 886-3-5770-955

**Taiwan - Kaohsiung**  
Tel: 886-7-536-4818  
Fax: 886-7-330-9305

**Taiwan - Taipei**  
Tel: 886-2-2500-6610  
Fax: 886-2-2508-0102

**Thailand - Bangkok**  
Tel: 66-2-694-1351  
Fax: 66-2-694-1350

### EUROPE

**Austria - Wels**  
Tel: 43-7242-2244-39  
Fax: 43-7242-2244-393

**Denmark - Copenhagen**  
Tel: 45-4450-2828  
Fax: 45-4485-2829

**France - Paris**  
Tel: 33-1-69-53-63-20  
Fax: 33-1-69-30-90-79

**Germany - Munich**  
Tel: 49-89-627-144-0  
Fax: 49-89-627-144-44

**Italy - Milan**  
Tel: 39-0331-742611  
Fax: 39-0331-466781

**Netherlands - Drunen**  
Tel: 31-416-690399  
Fax: 31-416-690340

**Spain - Madrid**  
Tel: 34-91-708-08-90  
Fax: 34-91-708-08-91

**UK - Wokingham**  
Tel: 44-118-921-5869  
Fax: 44-118-921-5820

08/02/11